

## DESIGN RADIATOR VALVES TWIN SERIES



### arredoalvola®

The arredoalvola radiator valves is the design line specifically developed for radiators and towel rails. High quality of products, sophisticated style, variety of models and different types of finishing allow to perfectly and elegantly harmonize with any style of interior decoration with the precise intention to emphasise the beauty of the technology within the everyday use of our products.

Valves are available in straight or angle form with male thread. Pipe threads are according EN-ISO 228/1.

#### Technical characteristics:

Technical features	Symbol	Values
Medium		Water/water with glycol
Max. glycol percentage	%	30%
Dimensions	DN	15
Max. static pressure	PN	10 bar
Max. differential pressure	dP	0,8 bar [80 kPa]
Max. temperature	t max	110 °C

Element	Material
Body valves	Brass EN12165-CW 617N-M
Rubber components to seal:	EPDM peroxide
Steel components	INOX AISI302
Plastic components:	ABS
Other brass components	Brass EN12164-CW 617N-M

#### Standard:

All technical characteristics are provided according the European standard EN 215 "Thermostatic radiator valves. Requirements and test methods".

## DESIGN RADIATOR VALVES TWIN SERIES

### Models:

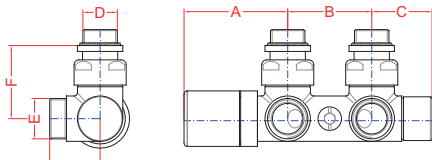

SB = for bitube systems (without by-pass).

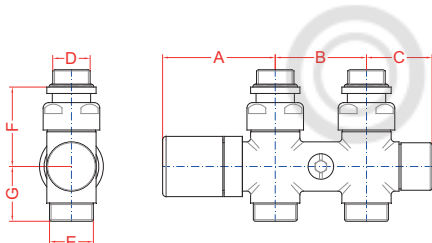

SB = for bitube systems (without by-pass).

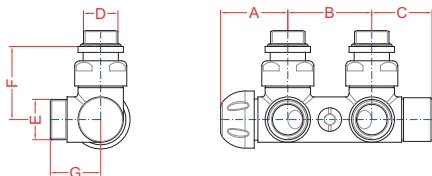

SB = for bitube systems (without by-pass).

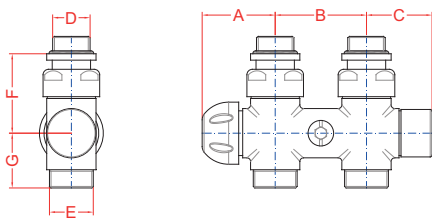

SB = for bitube systems (without by-pass).

### TWIN-THERMO SERIES

#### V421

Thermostatic mono/bitube angle H valve with manual handle for copper or plastic pipe. Body contains thermostatic valve and lockshield valve. Color finishing brass body. Distance between connections 50 mm. Connection for thermostatic head M30x1,5.

DN	D	E	A	B	C	F	G	Weight	Kvs	Code
			mm	mm	mm	mm	mm	kg	m <sup>3</sup> /h	
15	1/2"	24-19	62	50	36	44	30	0.647	2.05	<b>V42100_*</b>
15	1/2"	3/4" EK	62	50	36	44	30	0.647	2.05	<b>V42110_*</b>
15	1/2"	24-19	62	50	36	44	30	0.647	2.05	<b>V42100_SB*</b>
15	1/2"	3/4" EK	62	50	36	44	30	0.647	2.05	<b>V42110_SB*</b>

#### V425

Thermostatic mono/bitube straight H valve with manual handle for copper or plastic pipe. Body contains thermostatic valve and lockshield valve. Color finishing brass body. Distance between connections 50 mm. Connection for thermostatic head M30x1,5.

DN	D	E	A	B	C	F	G	Weight	Kvs	Code
			mm	mm	mm	mm	mm	kg	m <sup>3</sup> /h	
15	1/2"	24-19	62	50	36	44	30	0.684	2.10	<b>V42500_*</b>
15	1/2"	3/4" EK	62	50	36	44	30	0.684	2.10	<b>V42510_*</b>
15	1/2"	24-19	62	50	36	44	30	0.684	2.10	<b>V42500_SB*</b>
15	1/2"	3/4" EK	62	50	36	44	30	0.684	2.10	<b>V42510_SB*</b>

#### V371

Thermostatic mono/bitube angle H valve with protection cap for copper or plastic pipe. Body contains thermostatic valve and lockshield valve. Color finishing brass body. Distance between connections 50 mm. Connection for thermostatic head M30x1,5.

DN	D	E	A	B	C	F	G	Weight	Kvs	Code
			mm	mm	mm	mm	mm	kg	v	
15	1/2"	24-19	40	50	36	44	30	0.634	2.05	<b>V37100_*</b>
15	1/2"	3/4" EK	40	50	36	44	30	0.634	2.05	<b>V37110_*</b>
15	1/2"	24-19	40	50	36	44	30	0.634	2.05	<b>V37100_SB*</b>
15	1/2"	3/4" EK	40	50	36	44	30	0.634	2.05	<b>V37110_SB*</b>

#### V375

Thermostatic mono/bitube straight H valve with protection cap for copper or plastic pipe. Body contains thermostatic valve and lockshield valve. Color finishing brass body. Distance between connections 50 mm. Connection for thermostatic head M30x1,5.

DN	D	E	A	B	C	F	G	Weight	Kvs	Code
			mm	mm	mm	mm	mm	kg	m <sup>3</sup> /h	
15	1/2"	24-19	40	50	36	44	30	0.671	2.10	<b>V37500_*</b>
15	1/2"	3/4" EK	40	50	36	44	30	0.671	2.10	<b>V37510_*</b>
15	1/2"	24-19	40	50	36	44	30	0.671	2.10	<b>V37500_SB*</b>
15	1/2"	3/4" EK	40	50	36	44	30	0.671	2.10	<b>V37510_SB*</b>

\* It is necessary to specify the type of finishing at the end of code. For example for chrome: **V37110B**.



## DESIGN RADIATOR VALVES TWIN SERIES

### Models:

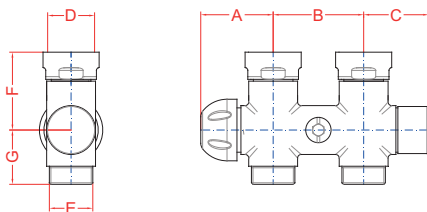
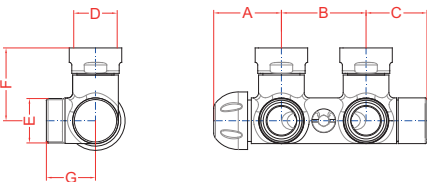
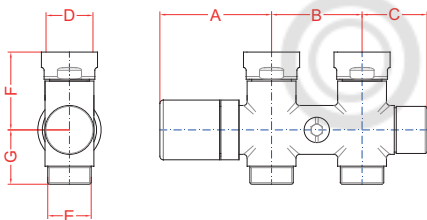
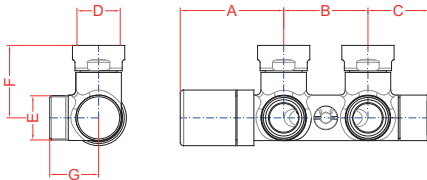

#### V423

Thermostatic mono/bitube angle H valve with manual handle for copper or plastic pipe. Body contains thermostatic valve and lockshield valve. Color finishing brass body. Distance between connections 50 mm. Flat seat connection. Connection for thermostatic head M30x1,5.

DN	D	E	A	B	C	F	G	Weight	Kvs	Code
			mm	mm	mm	mm	mm	kg	m <sup>3</sup> /h	
15	3/4" F	24-19	62	50	36	44	30	0.647	2.05	<b>V42300_*</b>
15	3/4" F	3/4" EK	62	50	36	44	30	0.647	2.05	<b>V42310_*</b>

#### V427

Thermostatic mono/bitube straight H valve with manual handle for copper or plastic pipe. Body contains thermostatic valve and lockshield valve. Color finishing brass body. Distance between connections 50 mm. Flat seat connection. Connection for thermostatic head M30x1,5.

DN	D	E	A	B	C	F	G	Weight	Kvs	Code
			mm	mm	mm	mm	mm	kg	m <sup>3</sup> /h	
15	3/4" F	24-19	62	50	36	44	30	0.684	2.10	<b>V42700_*</b>
15	3/4" F	3/4" EK	62	50	36	44	30	0.684	2.10	<b>V42710_*</b>

#### V373

Thermostatic mono/bitube angle H valve with protection cap for copper or plastic pipe. Body contains thermostatic valve and lockshield valve. Color finishing brass body. Distance between connections 50 mm. Flat seat connection. Connection for thermostatic head M30x1,5.

DN	D	E	A	B	C	F	G	Weight	Kvs	Code
			mm	mm	mm	mm	mm	kg	m <sup>3</sup> /h	
15	3/4" F	24-19	40	50	36	44	30	0.634	2.05	<b>V37300_*</b>
15	3/4" F	3/4" EK	40	50	36	44	30	0.634	2.05	<b>V37310_*</b>

#### V377

Thermostatic mono/bitube straight H valve with protection cap for copper or plastic pipe. Body contains thermostatic valve and lockshield valve. Color finishing brass body. Distance between connections 50 mm. Flat seat connection. Connection for thermostatic head M30x1,5.

DN	D	E	A	B	C	F	G	Weight	Kvs	Code
			mm	mm	mm	mm	mm	kg	m <sup>3</sup> /h	
15	3/4" F	24-19	40	50	36	44	30	0.671	2.10	<b>V37700_*</b>
15	3/4" F	3/4" EK	40	50	36	44	30	0.671	2.10	<b>V37710_*</b>

\* It is necessary to specify the type of finishing at the end of code. For example for chrome: **V37310B**.

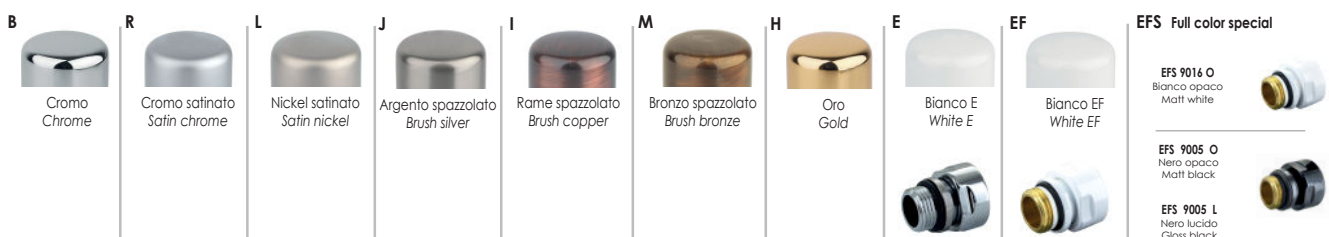

## DESIGN RADIATOR VALVES TWIN SERIES

### Models:

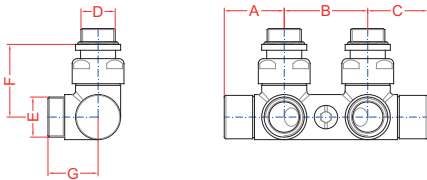

SB = for bitube systems (without by-pass).

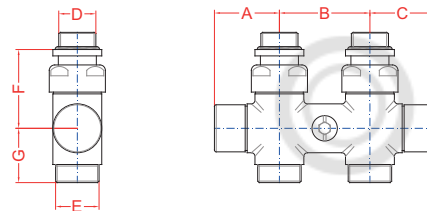

SB = for bitube systems (without by-pass).

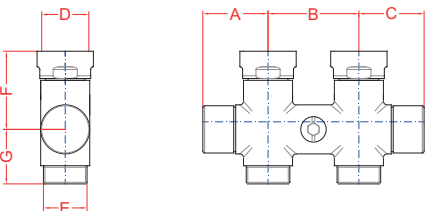
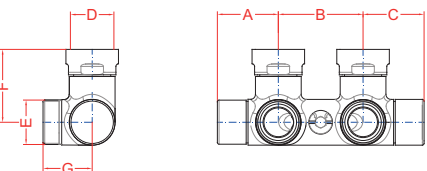

### TWIN SERIES

#### V481

Manual mono/bitube angle H valve brass cap for copper or plastic pipe. Body contains double lockshield. Color finishing brass body. Distance between connections 50 mm.

DN	D	E	A	B	C	F	G	Weight	Kvs	Code
			mm	mm	mm	mm	mm	kg	m <sup>3</sup> /h	
15	1/2"	24-19	36	50	36	44	30	0.646	2.36	<b>V48100_*</b>
15	1/2"	3/4" EK	36	50	36	44	30	0.646	2.36	<b>V48110_*</b>
15	1/2"	24-19	36	50	36	44	30	0.646	2.36	<b>V48100_SB*</b>
15	1/2"	3/4" EK	36	50	36	44	30	0.646	2.36	<b>V48110_SB*</b>

#### V485

Manual mono/bitube straight H valve with brass cap for copper or plastic pipe. Body contains double lockshield. Color finishing brass body. Distance between connections 50 mm.

DN	D	E	A	B	C	F	G	Weight	Kvs	Code
			mm	mm	mm	mm	mm	kg	m <sup>3</sup> /h	
15	1/2"	24-19	36	50	36	44	30	0.683	2.10	<b>V48500_*</b>
15	1/2"	3/4" EK	36	50	36	44	30	0.683	2.10	<b>V48510_*</b>
15	1/2"	24-19	36	50	36	44	30	0.683	2.10	<b>V48500_SB*</b>
15	1/2"	3/4" EK	36	50	36	44	30	0.683	2.10	<b>V48510_SB*</b>

### TWIN\_F SERIES

#### V483

Manual mono/bitube angle H valve with brass cap for copper or plastic pipe. Body contains double lockshield. Color finishing brass body. Distance between connections 50 mm. Flat seat connection.

DN	D	E	A	B	C	F	G	Weight	Kvs	Code
			mm	mm	mm	mm	mm	kg	m <sup>3</sup> /h	
15	3/4" F	24-19	36	50	36	44	30	0.646	2.36	<b>V48300_*</b>
15	3/4" F	3/4" EK	36	50	36	44	30	0.646	2.36	<b>V48310_*</b>

#### V487

Manual mono/bitube straight H valve with brass cap for copper or plastic pipe. Body contains double lockshield. Color finishing brass body. Distance between connections 50 mm. Flat seat connection.

DN	D	E	A	B	C	F	G	Weight	Kvs	Code
			mm	mm	mm	mm	mm	kg	m <sup>3</sup> /h	
15	3/4" F	24-19	36	50	36	44	30	0.683	2.10	<b>V48700_*</b>
15	3/4" F	3/4" EK	36	50	36	44	30	0.683	2.10	<b>V48710_*</b>

\* It is necessary to specify the type of finishing at the end of code. For example for chrome: **V48510B**.

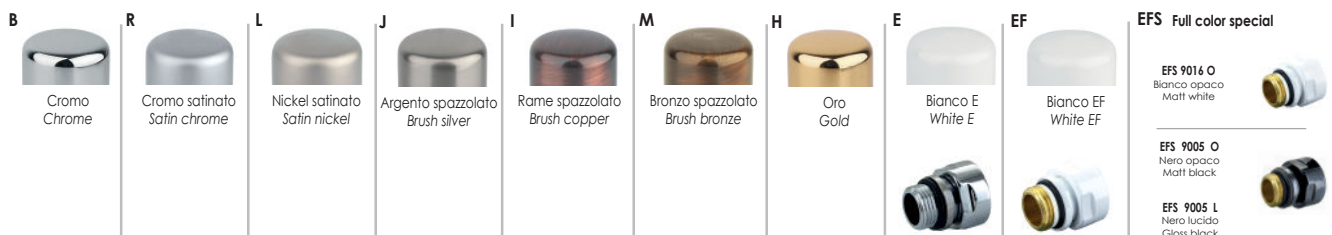

## DESIGN RADIATOR VALVES TWIN SERIES

### Models:

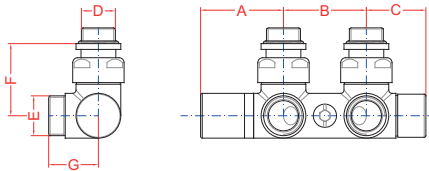

SB = for bitube systems (without by-pass).

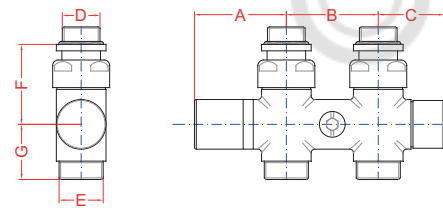

SB = for bitube systems (without by-pass).

### TWIN-06 SERIES

#### V42106

Thermostatic mono/bitube angle H valve with brass handle for copper or plastic pipe. Body contains thermostatic valve and lockshield valve. Color finishing brass body. Distance between connections 50 mm. Connection for thermostatic head M30x1,5 with adapter art. A400.

DN	D	E	A	B	C	F	G	Weight	Kvs	Code
			mm	mm	mm	mm	mm	kg	m <sup>3</sup> /h	
15	1/2"	24-19	50	50	36	44	30	0.647	2.05	<b>V4210611_*</b>
15	1/2"	3/4" EK	50	50	36	44	30	0.647	2.05	<b>V4210612_*</b>
15	1/2"	24-19	50	50	36	44	30	0.647	2.05	<b>V4210611_SB*</b>
15	1/2"	3/4" EK	50	50	36	44	30	0.647	2.05	<b>V4210612_SB*</b>

#### V42506

Thermostatic mono/bitube straight H valve with brass handle for copper or plastic pipe. Body contains thermostatic valve and lockshield valve. Color finishing brass body. Distance between connections 50 mm. Connection for thermostatic head M30x1,5 with adapter art. A400.

DN	D	E	A	B	C	F	G	Weight	Kvs	Code
			mm	mm	mm	mm	mm	kg	m <sup>3</sup> /h	
15	1/2"	24-19	50	50	36	44	30	0.684	2.10	<b>V4250611_*</b>
15	1/2"	3/4" EK	50	50	36	44	30	0.684	2.10	<b>V4250612_*</b>
15	1/2"	24-19	50	50	36	44	30	0.684	2.10	<b>V4250611_SB*</b>
15	1/2"	3/4" EK	50	50	36	44	30	0.684	2.10	<b>V4250612_SB*</b>

\* It is necessary to specify the type of finishing at the end of code. For example for chrome: **V48510B**.

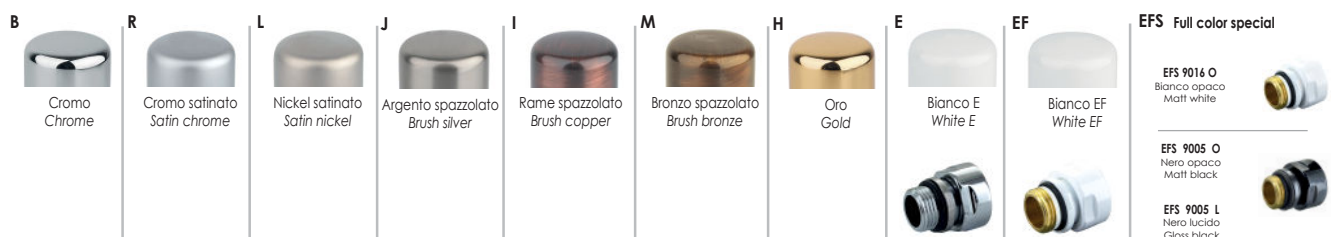

## DESIGN RADIATOR VALVES TWIN SERIES

### Valve application:

The thermostatic mono/bitube H radiator valves are designed to be equipped with a presetting thermostatic spindle which allows regulation of the flow rate to the radiator, achieving balance of the circuit. The single valve body contains both elements: thermostatic valve and lockshield. The valves are predisposed for mounting the thermostatic head in order to maintain a constant set temperature value, resulting in a considerable energy saving. The lockshield radiator valves are used for shut off the radiator in case of maintenance and regulating the flow rate in the case of thermostatic valves without presetting or manual valves.

### Cross section:

#### Thermostatic TWIN valves

N	Details
1	Valve body
2	Valve disc
3	By-pass
4	Union nut
5	Tailpiece
6	Valve stem
7	O-Ring
8	Plastic cap
9	Lockshield headwork
10	Lockshield cap

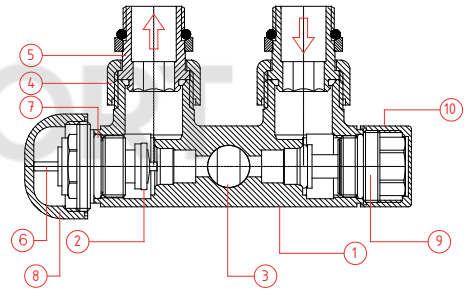

#### Manual TWIN valves

N	Details
1	Valve body
2	Shut off spindle
3	By-pass
4	Union nut
5	Tailpiece
6	O-Ring
7	O-Ring
8	Brass cap
9	Lockshield headwork

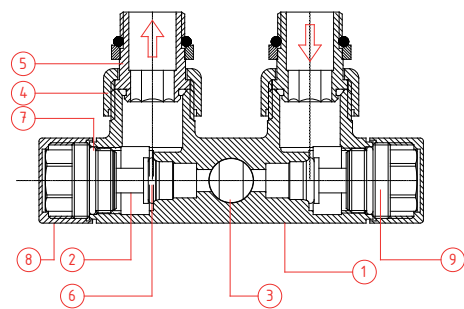



**DESIGN RADIATOR VALVES**  
**TWIN SERIES**

**Thermostatic TWIN\_F valves**

N	Details
1	Valve body
2	Valve disc
3	By-pass
4	Union nut
5	O-Ring
6	Valve stem
7	O-Ring
8	Plastic cap
9	Lockshield headwork
10	Lockshield cap

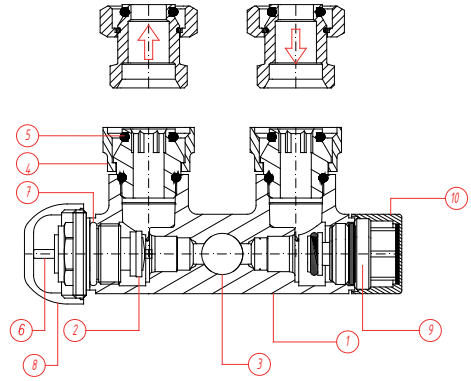

**Manual TWIN\_F valves**

N	Details
1	Valve body
2	Shut off spindle
3	By-pass
4	O-Ring
5	Union nut
6	O-Ring
7	Lockshield cap

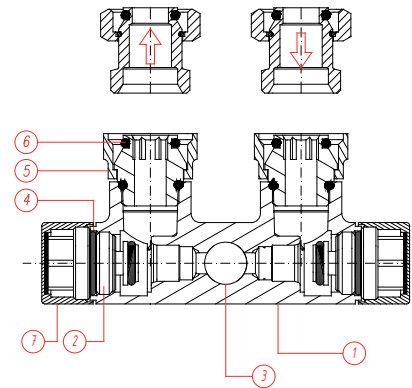

## DESIGN RADIATOR VALVES TWIN SERIES

### Configurations of the valve:

#### Thermostatic TWIN valves

The mono/bitube H radiator valve can work as in one pipe systems and in two pipe systems (excluding models without by-pass **SB** which are working only in two pipe systems).

Angle version

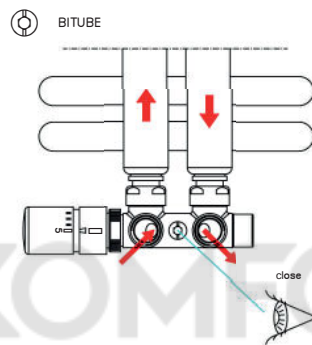

Straight version

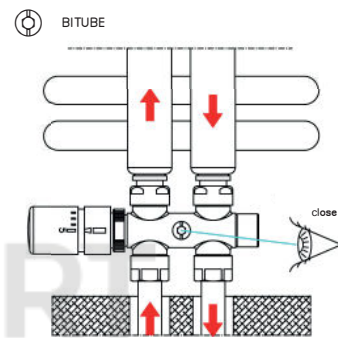

Angle version

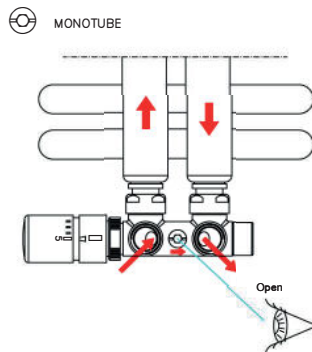

Straight version

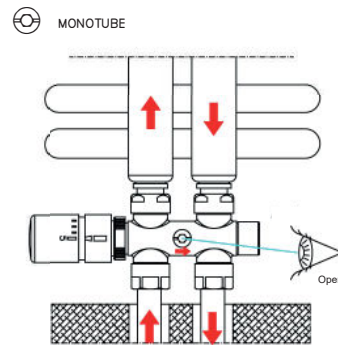

The by-pass of the valve allowed flow to pass in order of radiator maintenance allowing the system to work in the moment of disconnection of one of the consumers.

The by-pass construction of the valve allowed to include bath radiators in the loop of underfloor heating systems.

In order to change configuration of the valve from monotube to bitube close the by-pass using 6 mm Allen key rotating it in vertical direction as shown in the picture. Open the by-pass in order to make monotube configuration.

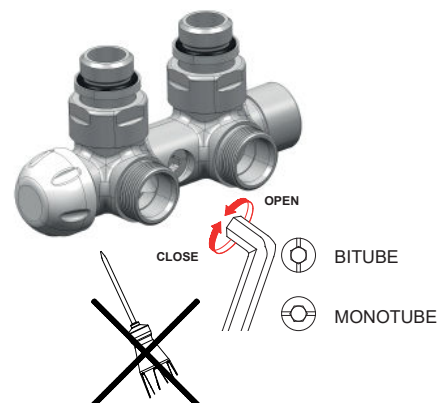



## DESIGN RADIATOR VALVES TWIN SERIES

### Configurations of the valve:

#### Thermostatic TWIN F-THERMO valves

The mono/bitube H radiator valve can work as in one pipe systems and in two pipe systems.

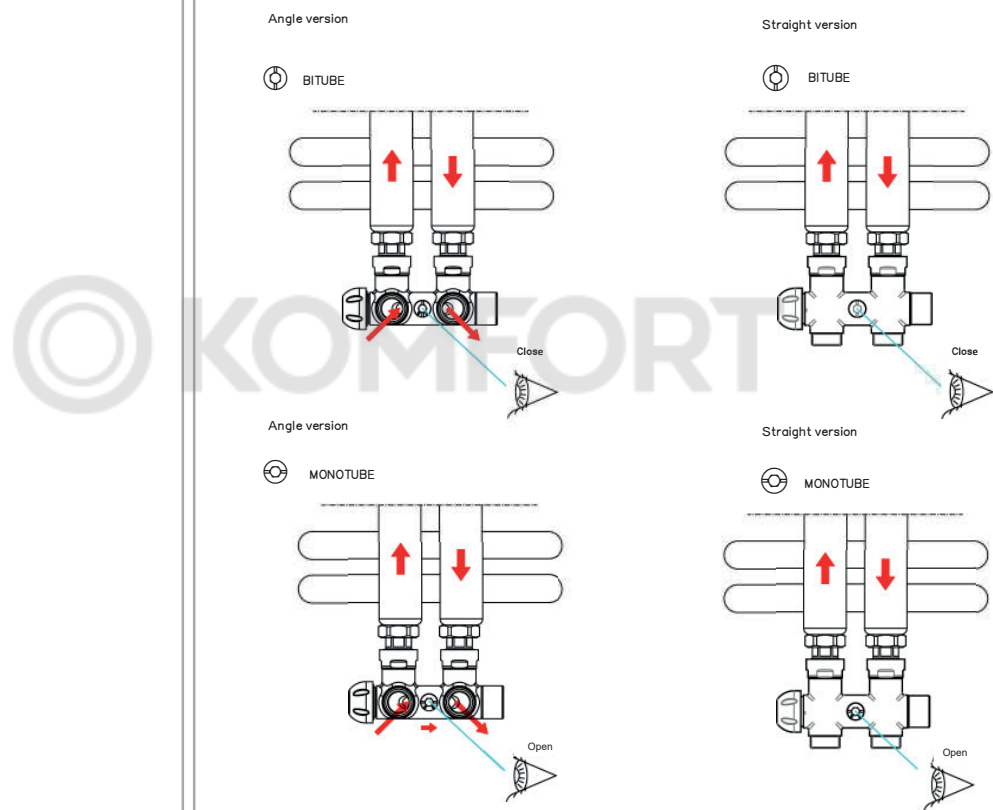

The by-pass of the valve allowed flow to pass in order of radiator maintenance allowing the system to work in the moment of disconnection of one of the consumers.

The by-pass construction of the valve allowed to include bath radiators in the loop of underfloor heating systems.

In order to change configuration of the valve from monotube to bitube close the by-pass using 6 mm Allen key rotating it in vertical direction as shown in the picture. Open the by-pass in order to make monotube configuration.

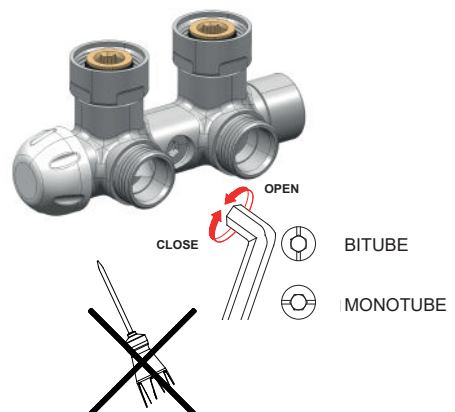

## DESIGN RADIATOR VALVES TWIN SERIES

### Operating principle of the valve:

#### Thermostatic models with presetting

The thermostatic valves are equipped with pre-setting headwork that allows to balance the flow of the circuit. The flow regulation consists of a calibrated limitation of the valve passage obtained by rotating the selector on the valve. The hydraulic characteristics connected to each preset are shown at the end of this technical data sheet.

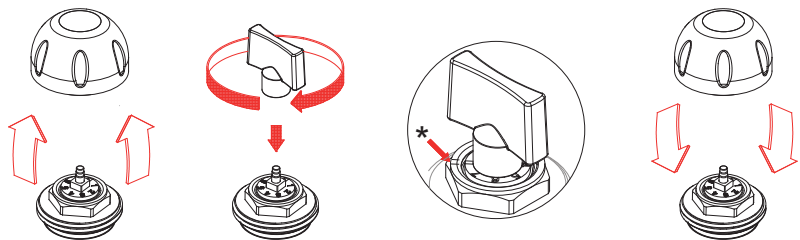

In order to install preset position on the valve follow instructions below:

- remove the cap / handwheel (1);
- close completely the presetting ring nut, using the key (2); then reopen to the position of pre-setting expected by the project or selected on the specific diagram, matching the number to the reference sign (\*); for the maximum (full open) position take another full turn of the ring setting the reference mark on the number 7;
- reassemble the cap / handwheel (3) so as to obtain the valve with presetting (4).

#### Manual valves:

Manual valves regulate the flow rate through manual shutter adjustment, rotating manually the handwheel on the body of the valve.

Rotating the handwheel clockwise, you close the valve, while turning the handwheel in the counterclockwise direction, you open the valve.

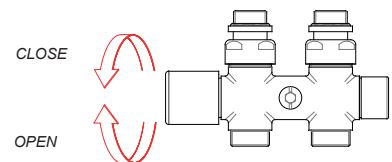

#### Lockshields:

To shut off the valve in case of maintenance:

- remove the cap;
- close the valve using 6 mm Allen key rotating it in clockwise direction;
- install the cap.

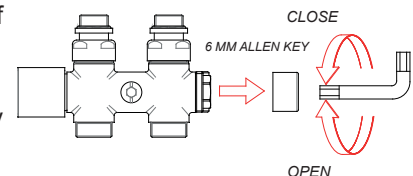

The balancing with lockshield can be made starting from a completely closed valve and opening it proportionally up to desired flow rate. The complete opening is obtained with about 4 turns.

## DESIGN RADIATOR VALVES TWIN SERIES

### Installation of the valve:

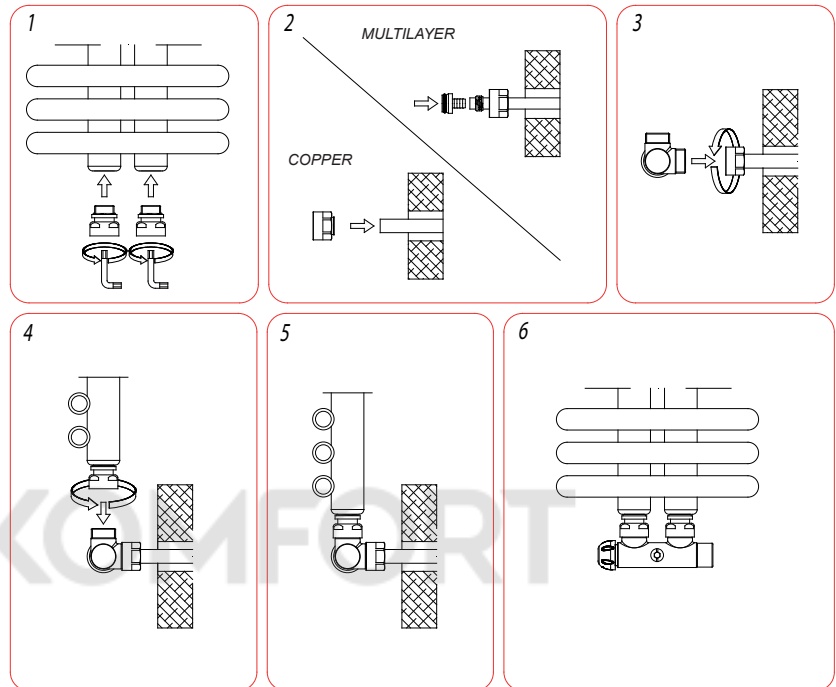

The thermostatic/manual valve should be installed in the bottom part of the radiator according flow direction instructions. Valves are available in straight or angled version with Eurocone (EK) connection. The radiator connection is made through the tail piece connection for TWIN series or valve nut and different types of adapters (Art. A554-A553) for TWIN\_F series .

- close the riser and drain the water from the radiator;
- For TWIN\_F series install the adapters (A554 or A553) in the radiator connections if necessary. Screw the valve body to the radiator;
- For TWIN series remove the nut with the tail piece from the valve, screw the union onto the radiator after having threaded it with hemp or PTFE tapes (2). This last step is not necessary if the tail piece is equipped with a seal;
- perform a precise and perpendicular cut of the tube, free from burrs, using a special pipe cutter;
- give the tube its original cylindrical shape to facilitate the insertion of the hose holder;
- check that there are no traces of burr and dirt inside the tube;
- assemble the elements that make up the joint according to the order shown in the picture on the left, paying attention to the type of pipe and therefore the connection that is being used (1);
- insert the pipe with its hose connector into the valve seat, avoiding to pinch the sealing o-ring. Fit the nut and screw it by hand as far as possible, then use the appropriate key to screw it all the way in (3);
- screw the valve body to the radiator (4).

## DESIGN RADIATOR VALVES TWIN SERIES

### Thermostatic heads:

The thermostatic heads are used with thermostatically controlled valves to regulate the room temperature automatically.  
The following models are compatible with the thermostatic valves:

Model	Sensor type	Control type	Connection size	Setting range	Max. response time	Color	Code
A409	liquid	built-in	M30x1,5	6.5 to 28 °C	13 min	vary	A40900_*
A499	liquid	built-in	M30x1,5	7 to 30 °C	40 min	chrome	A49900B
A498	liquid	built-in	M30x1,5	6.5 to 28 °C	23 min	vary	A49800_*
A497	liquid	built-in	M30x1,5	6 to 28 °C	16 min	chrome	A49700B
A425	liquid	built-in	M30x1,5	7 to 30 °C	25 min	chrome	A42500B

\* In order to specify finishing instead of \_ add at the end of code desired finishing (according available colors, see the list of model). Example for chrome: **A40900B**.

**Note:** For TWIN\_06 series use the adaptor **A400** (see accessories).

### Operating principle:

The thermostatic head contains a temperature sensitive element (liquid). Together with the thermostatic valve it provides proportional temperature regulation in room where it is install. When the ambient temperature is higher than was preset with scale settings, the volume of liquid in thermostatic head expands and push the stem of the valve on order to close the flow rate and thereby reducing its heat transfer. As the temperature decrease it is starts the opposite process.

**Note:** In the case of long periods of absence specially during winter, set the thermostatic head to the antifreeze position ❄ (which corresponds to the minimum temperature from setting range). During the summer season however it is advisable to set the thermostatic to set the n°5 setting or with the valve fully open.

### Regulation of temperature with thermostatic head:

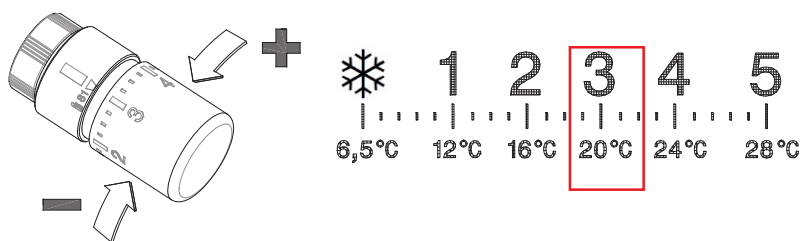

**! Attention:** The thermostatic head does not use for shutoff the valve. In case of disassembling of heat emitter take off the thermostatic head and use the protection cap or handle.

It is essential that the thermostat is placed in the correct way: **HORIZONTALLY** as shown in the picture below.

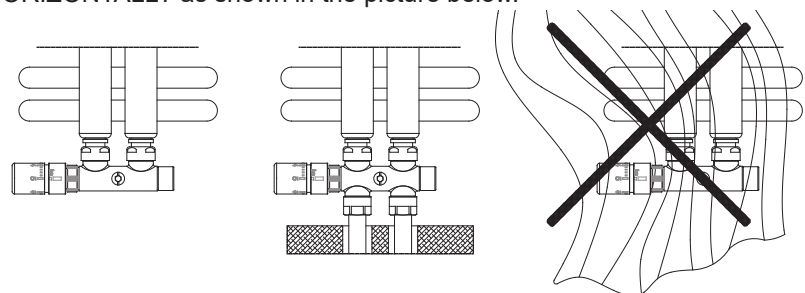

**Note:** It is not permitted to mount the thermostatic head vertically, in niches, and should not be covered by curtains. The sensitive element should not be placed in direct sunlight exposure.

## DESIGN RADIATOR VALVES TWIN SERIES

### Installation of the thermostatic head:

#### TWIN-THERMO series

The thermostatic head should be installed in a horizontal position.

- take off the protection cap/handle.
- select PRESETTING 5 on the thermostatic head.
- install the thermostatic head by screwing the ring nut manually.

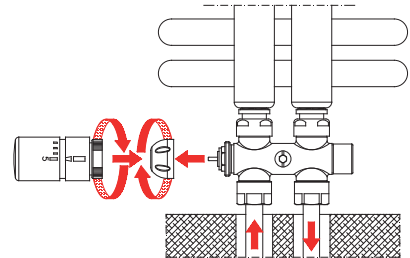

**Note:** Cap can be used for manual control during the installation and it should be used as isolation device.

#### TWIN-06 series

In order to install thermostatic head follow instructions below:

- take off the brass handle of the valve;
- take off the threaded element using CH 20 rotating it in the counterclockwise direction;
- install adaptor **A400** (see in the accesoreies) screwing the ring nut manually;
- fix the adaptor with screw using 2 mm Allen key rotating it in clockwise direction;
- select PRESETTING "5" on the thermostatic head;
- install the thermostatic head by \*ADAPTOR screwing the ring nut manually.

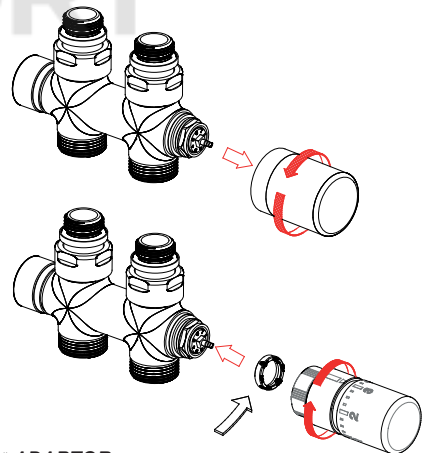

## DESIGN RADIATOR VALVES TWIN SERIES

### Adaptors:

\* Adaptors are used with V421, V425, V371, V375, V481, V485, V42106, V42506, V423, V427, V373, V377, V483 and V487 valve models.

**⚠ Attention:** To install the Arredoalvola series adaptors it is necessary to pay attention in order not to damage the surface finish, use suitable keys. Use the tightening torque specified in the data sheet of the chosen adapter.

### COPPER PIPES

Model	Description	Max. pressure	Size	Connection	Code
	Adaptor for copper pipe, exagonal nut.	10 bar	10	24-19	<b>A33106_*</b>
			12	24-19	<b>A33107_*</b>
			14	24-19	<b>A33108_*</b>
			15	24-19	<b>A33109_*</b>
			16	24-19	<b>A33110_*</b>
			18	24-19	<b>A33111_*</b>
	Adaptor for copper pipe, cylindrical nut.	10 bar	10	24-19	<b>A58406_*</b>
			12	24-19	<b>A58407_*</b>
			14	24-19	<b>A58408_*</b>
			15	24-19	<b>A58409_*</b>
			16	24-19	<b>A58410_*</b>
			18	24-19	<b>A58411_*</b>
	Seal kit for copper pipe.	-	10	24-19	<b>A33306A</b>
			12	24-19	<b>A33307A</b>
			14	24-19	<b>A33308A</b>
			15	24-19	<b>A33309A</b>
			16	24-19	<b>A33310A</b>
	Adaptor for copper pipe, brass ogive.	10 bar	15	24-19	<b>A59300_*</b>
	Adaptor for copper pipe.	10 bar	10	3/4"EK	<b>A43301_*</b>
			12	3/4"EK	<b>A43302_*</b>
			14	3/4"EK	<b>A43303_*</b>
			15	3/4"EK	<b>A43304_*</b>
			16	3/4"EK	<b>A43305_*</b>
				Adaptor for copper pipe.	10 bar
12	3/4"EK	<b>A33107_*</b> <b>EK</b>			
14	3/4"EK	<b>A33108_*</b> <b>EK</b>			
15	3/4"EK	<b>A33109_*</b> <b>EK</b>			
16	3/4"EK	<b>A33110_*</b> <b>EK</b>			
18	3/4"EK	<b>A33111_*</b> <b>EK</b>			

### Type of connections:

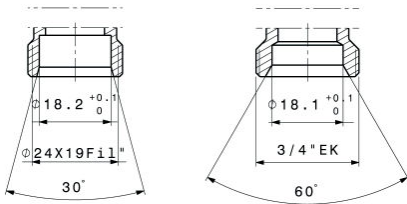

\* It is necessary to specify the type of finishing at the end of code. For example for chrome: **A33107B**.

<b>B</b>	<b>R</b>	<b>L</b>	<b>J</b>	<b>I</b>	<b>M</b>	<b>H</b>	<b>E</b>	<b>EF</b>	<b>EFS Full color special</b>
Cromo Chrome	Cromo satinato Satin chrome	Nickel satinato Satin nickel	Argento spazzolato Brush silver	Rame spazzolato Brush copper	Bronzo spazzolato Brush bronze	Oro Gold	Bianco E White E	Bianco EF White EF	EFS 9005 O Nero opaco Matt black
									EFS 9005 L Nero lucido Glass black







## DESIGN RADIATOR VALVES TWIN SERIES

### Adaptors:













\* Adaptors are used with V421, V425, V371, V375, V481, V485, V42106, V42506, V423, V427, V373, V377, V483 and V487 valve models.

**⚠ Attention:** To install the ArredoValvola series adaptors it is necessary to pay attention in order not to damage the surface finish, use suitable keys. Use the tightening torque specified in the data sheet of the chosen adaptor.

### MULTILAYER PIPES

Model	Description	Max. pressure	Size	Connection	Code								
	A555	Adaptor for multilayer pipe, exagonal nut.	10 bar	14x2	24-19	<b>A55501_*</b>							
				16x2	24-19	<b>A55502_*</b>							
				16x2.25	24-19	<b>A55503_*</b>							
				16.2x2.6	24-19	<b>A55513_*</b>							
				17x2	24-19	<b>A55504_*</b>							
				18x2	24-19	<b>A55506_*</b>							
				20x2	24-19	<b>A55510_*</b>							
				20x2.25	24-19	<b>A55511_*</b>							
				20x2.5	24-19	<b>A55512_*</b>							
				14x2	24-19	<b>A58501_*</b>							
				16x2	24-19	<b>A58502_*</b>							
				16x2.25	24-19	<b>A58503_*</b>							
	A585	Adaptor for multilayer pipe, cylindrical nut.	10 bar	16.2x2.6	24-19	<b>A58513_*</b>							
				17x2	24-19	<b>A58504_*</b>							
				18x2	24-19	<b>A58506_*</b>							
				20x2	24-19	<b>A58510_*</b>							
				20x2.25	24-19	<b>A58511_*</b>							
				20x2.5	24-19	<b>A58512_*</b>							
					A332	Exagonal nut for copper, PEX, multilayer pipe.	10 bar	16.8	24-19	<b>A33200_*</b>			
	A33210	Cylindrical nut for copper, PEX, multilayer pipe.	10 bar								16.8	24-19	<b>A33210_*</b>
	A587	Adaptor for multilayer pipe.	10 bar	14x2	3/4"EK	<b>A58701_*</b>							
				16x2	3/4"EK	<b>A58702_*</b>							
				16x2.25	3/4"EK	<b>A58703_*</b>							
				17x2	3/4"EK	<b>A58704_*</b>							
				18x2	3/4"EK	<b>A58706_*</b>							
				20x2	3/4"EK	<b>A58708_*</b>							
				20x2.25	3/4"EK	<b>A58709_*</b>							
				20x2.5	3/4"EK	<b>A58707_*</b>							

\* It is necessary to specify the type of finishing at the end of code. For example for chrome: **A55502B**.

B	R	L	J	I	M	H	E	EF	EFS Full color special
									
Cromo Chrome	Cromo satinato Satin chrome	Nickel satinato Satin nickel	Argento spazzolato Brush silver	Rame spazzolato Brush copper	Bronzo spazzolato Brush bronze	Oro Gold	Bianco E White E	Bianco EF White EF	EFS 9005 O Nero opaco Matt black
									EFS 9005 L Nero lucido Glass black



## DESIGN RADIATOR VALVES TWIN SERIES

### Adaptors:













\* Adaptors are used with V421, V425, V371, V375, V481, V485, V42106, V42506, V423, V427, V373, V377, V483 and V487 valve models.

**⚠ Attention:** To install the Arredoalvola series adapters it is necessary to pay attention in order not to damage the surface finish, use suitable keys. Use the tightening torque specified in the data sheet of the chosen adapter.

### PLASTIC PIPES

Model	Description	Max. pressure	Size	Connection	Code
 A556	Adaptor for plastic pipe, exagonal nut.	10 bar	12x2	24-19	<b>A55601_*</b>
			14x2	24-19	<b>A55602_*</b>
			15x2.5	24-19	<b>A55604_*</b>
			16x1.5	24-19	<b>A55605_*</b>
			16x2	24-19	<b>A55606_*</b>
			16x2.2	24-19	<b>A55607_*</b>
			17x2	24-19	<b>A55608_*</b>
			18x2	24-19	<b>A55610_*</b>
			18x2.5	24-19	<b>A55611_*</b>
			20x2	24-19	<b>A55613_*</b>
 A586	Adaptor for plastic pipe, cylindrical nut.	10 bar	20x2.5	24-19	<b>A55614_*</b>
			12x2	24-19	<b>A58601_*</b>
			14x2	24-19	<b>A58602_*</b>
			15x2.5	24-19	<b>A58604_*</b>
			16x2	24-19	<b>A58606_*</b>
			16x2.25	24-19	<b>A58607_*</b>
			17x2	24-19	<b>A58608_*</b>
			18x2	24-19	<b>A58610_*</b>
			18x2.5	24-19	<b>A58611_*</b>
			20x2	24-19	<b>A58613_*</b>
20x2.5	24-19	<b>A58615_*</b>			
 A588	Adaptor for PEX pipe.	10 bar	12x1.1	3/4"EK	<b>A58810_*</b>
			12x2	3/4"EK	<b>A58800_*</b>
			14x2	3/4"EK	<b>A58801_*</b>
			15x2.5	3/4"EK	<b>A58802_*</b>
			16x1.5	3/4"EK	<b>A58811_*</b>
			16x2	3/4"EK	<b>A58803_*</b>
			16x2.2	3/4"EK	<b>A58804_*</b>
			17x2	3/4"EK	<b>A58805_*</b>
			18x2	3/4"EK	<b>A58806_*</b>
			18x2.5	3/4"EK	<b>A58807_*</b>
20x2	3/4"EK	<b>A58808_*</b>			
20x2.5	3/4"EK	<b>A58809_*</b>			



\* It is necessary to specify the type of finishing at the end of code. For example for chrome: **A55606B**.

<b>B</b>  Cromo Chrome	<b>R</b>  Cromo satinato Satin chrome	<b>L</b>  Nickel satinato Satin nickel	<b>J</b>  Argento spazzolato Brush silver	<b>I</b>  Rame spazzolato Brush copper	<b>M</b>  Bronzo spazzolato Brush bronze	<b>H</b>  Oro Gold	<b>E</b>  Bianco E White E	<b>EF</b>  Bianco EF White EF	<b>EFS Full color special</b>  EFS 9016 O Bianco opaco Matt white   EFS 9005 O Nero opaco Matt black   EFS 9005 L Nero lucido Glass black 
--	---	--	---	--	--	--	---	---	--















## DESIGN RADIATOR VALVES TWIN SERIES

### Accessories and spare parts:









 **Attention:** The tightening torque of the screws must be less than 25 Nm.

	Model	Description	Size	Connection	Code	
	A353	Thermostatic spindle with presetting.	1/2"	M 30x1.5	<b>A35317TPS</b>	
				M 24x1.5	<b>A35325T</b>	
	A357	Headwork for manual valves.	1/2"		<b>A35711T</b>	
	A3570	Headwork for lockshield valves.	1/2"	M 24x1.5	<b>A35703T</b>	
	A343	Adaptor for iron pipe.		3/8"F	24-19	<b>A34301_*</b>
				1/2"F	24-19	<b>A34302_*</b>
				3/8"F	3/4"EK	<b>A34305_*</b>
				1/2"F	3/4"EK	<b>A34306_*</b>
				1/2"F NPT	24-19	<b>A34302_NPT</b>
			1/2"F NPT	3/4"EK	<b>A34306_NPT</b>	
	A547	Sleeving kit (pair).	18-L70	int. 50 mm	<b>A54703_*</b>	
			18-L160	int. 50 mm	<b>A54700_*</b>	
			18-L70	int. 40 mm	<b>A54605_*</b>	
			18-L160	int. 40 mm	<b>A54604_*</b>	
	A54750	Sleeving kit (pair).	16-L120	int. 50 mm	<b>A54650_*</b>	
			16-L120	int. 40 mm	<b>A54653_*</b>	
	A56950	Plastic sleeve with sliding drawer dn 45 mm.	45-10	-	<b>A56950_*</b>	
			45-12	-	<b>A56952_*</b>	
			45-14	-	<b>A56954_*</b>	
			45-15	-	<b>A56955_*</b>	
			45-16	-	<b>A56956_*</b>	
			45-18	-	<b>A56958_*</b>	
	A344	Nut and tail piece with O-RING	3/8"	3/4"	<b>A34400_*</b>	
			1/2"	3/4"	<b>A34410_*</b>	
			3/8"	24-19	<b>A34494_*</b>	
			1/2"	24-19	<b>A34492_*</b>	
	A354	Protection cap for thermostatic valve	-	M 30x1.5	<b>A35402A</b>	

\* It is necessary to specify the type of finishing at the end of code. For example for chrome: **V37110B**.

B	R	L	J	I	M	H	E	EF	EFS Full color special
									<b>EFS 9016 O</b> Bianco opaco Matt white 
									<b>EFS 9005 O</b> Nero opaco Matt black 
									<b>EFS 9005 L</b> Nero lucido Glass black 

## DESIGN RADIATOR VALVES TWIN SERIES

	Model	Description	Size	Connection	Code
	NV27201	Cap for lockshield valve. Chrome plated.	-	M 30x1.5	<b>NV27201_*</b>
	A574	Handwheel for thermostatic valve.	-	M 30x1.5	<b>A57400A</b>
	NV32106	Handwheel for "06" model.	-	M 24x1.5	<b>NV32106T</b>
	A400	TRV head adaptor for "06" models.	M 30x1.5	M 24x1.5	<b>A40001T</b>
	A554	Reduction with O-Ring.	1/2"	3/4"	<b>A55400T</b>
	A554	Reduction with O-Ring.	1/2"	3/4"	<b>A55401T</b>
	A553	Conical adaptor with O-Ring.			<b>A55300T</b>
	A630	Pre-setting key.	M 30x1.5		<b>A63000A</b>

### Theoretical references:

#### Koefficient of flow [ Kv ]

The **Kv** value expresses the amount of flow rate in m<sup>3</sup>/h that pass through the regulating valve **at a given preset position** in one hour with a differential pressure across the valve 1 bar.

In order to determine valve size, calculate the flow rate with the following formula:

$$Q = Kv * \sqrt{\Delta p \frac{1000}{\rho}}$$

Where:

Q - is the flow rate in m<sup>3</sup>/h;

Δp - is the differential pressure across the valve in bar

ρ - is the density of passing liquid in kg/m<sup>3</sup>.

The **Kvs** is the Kv value of fully open valve.

#### Proportional band [ Xp ]

A proportional band of a valve is defined as the change in the required room temperature so that the closed valve is operated to allow reaching the design flow rate.

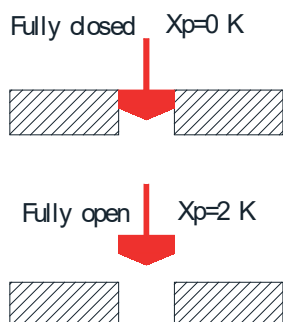

## DESIGN RADIATOR VALVES TWIN SERIES

### Hydraulic characteristics:

**V421**  
**V423**  
**V371**  
**V373**  
**V42106**  
Angle valve  
DN15 1/2"

Pre-setting	Kv
N	m <sup>3</sup> /h
	1 0.30
	2 0.74
	3 1.07
	4 1.36
	5 1.57
	6 1.74
	7 1.83
<b>Kvs</b>	<b>2.05</b>

The diagrams show the values of the valve head losses in the different preset positions. For each of them is shown the corresponding Kv values.

TWIN THERMO PRESET BITUBE  
ANGLE DN 15 1/2"

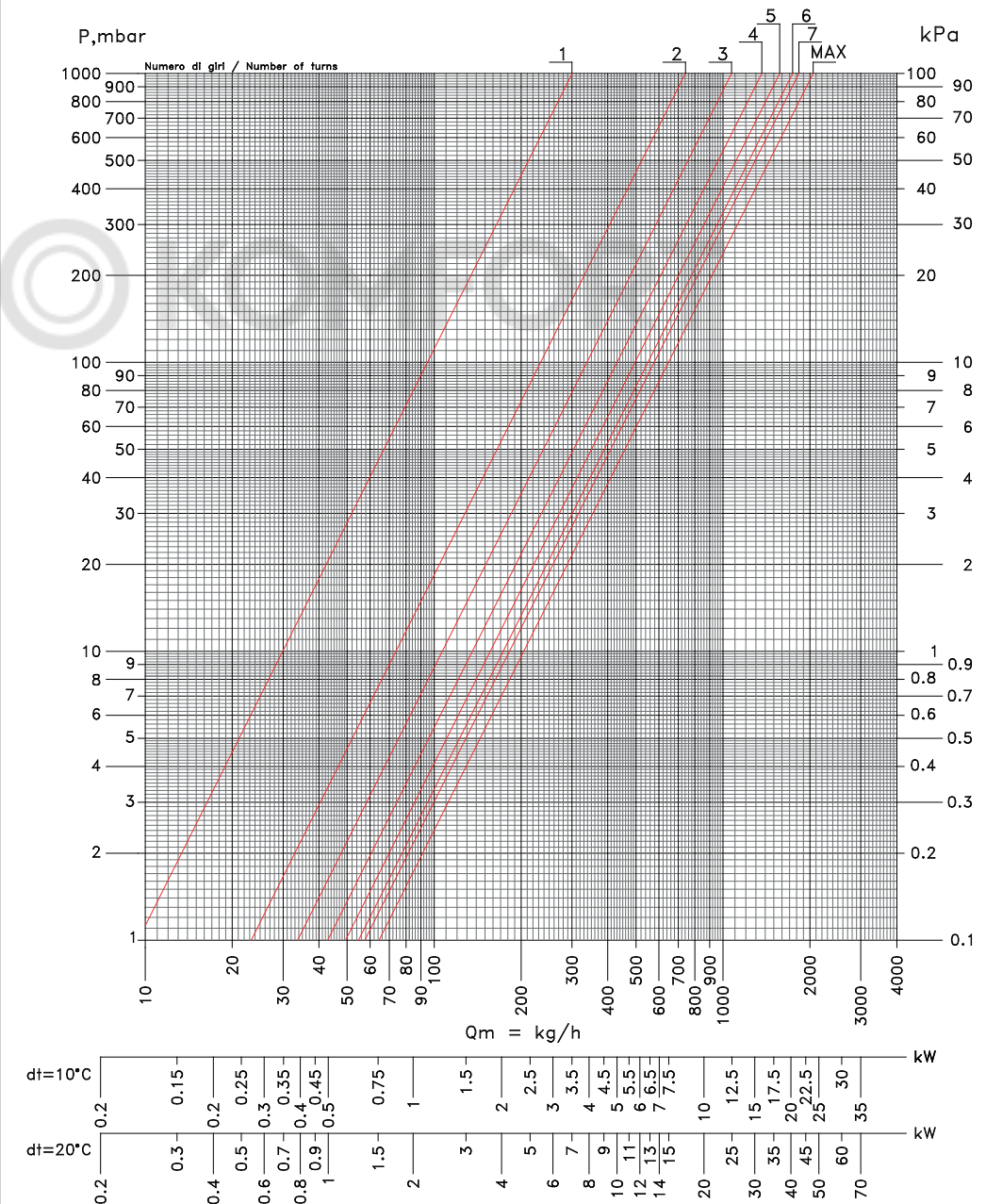

**Note:** To avoid excessive noisiness in the circuit, avoid using thermostatic valves with  $\Delta p$  values of more than 0,2 - 0,25 bar [20-25 kPa].



## DESIGN RADIATOR VALVES TWIN SERIES

### Hydraulic characteristics:

**V421  
V423  
V371  
V373  
V42106**  
Angle valve  
DN15 1/2"

Pre-setting	Kv
N	m <sup>3</sup> /h
	1.60
	1.80
	1.95
	2.05
	2.10
	2.12
	2.14
<b>Kvs</b>	<b>m<sup>3</sup>/h</b>
	2.16

The diagrams show the values of the valve head losses in the different preset positions. For each of them is shown the corresponding Kv values.

TWIN PRESET MONOTUBE  
ANGLE DN 15 1/2"

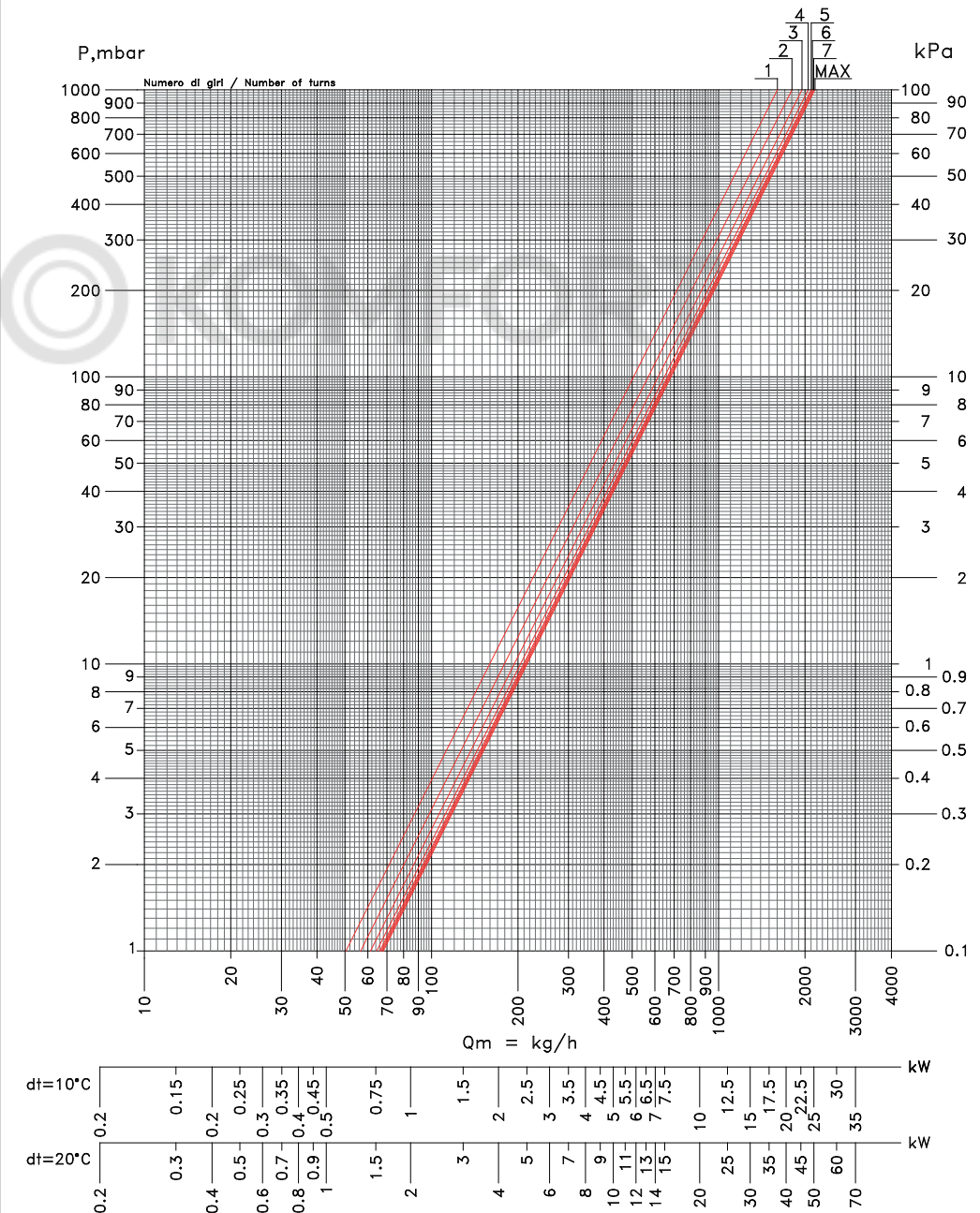

**Note:** To avoid excessive noisiness in the circuit, avoid using thermostatic valves with  $\Delta p$  values of more than 0,2 - 0,25 bar [20-25 kPa].



## DESIGN RADIATOR VALVES TWIN SERIES

### Hydraulic characteristics:

**V425**  
**V427**  
**V375**  
**V377**  
**V42506**  
Straight valve  
DN15 1/2"

Pre-setting	Kv	a
N	m <sup>3</sup> /h	
	1	0.35 0.97
	2	0.80 0.86
	3	1.12 0.72
	4	1.38 0.57
	5	1.55 0.45
	6	1.70 0.34
	7	1.82 0.25
<b>Kvs</b>	<b>m<sup>3</sup>/h</b>	<b>2.10 0.00</b>

The diagrams show the values of the valve head losses in the different preset positions. For each of them is shown the corresponding Kv values.

TWIN THERMO PRESET BITUBE  
STRAIGHT DN 15 1/2"

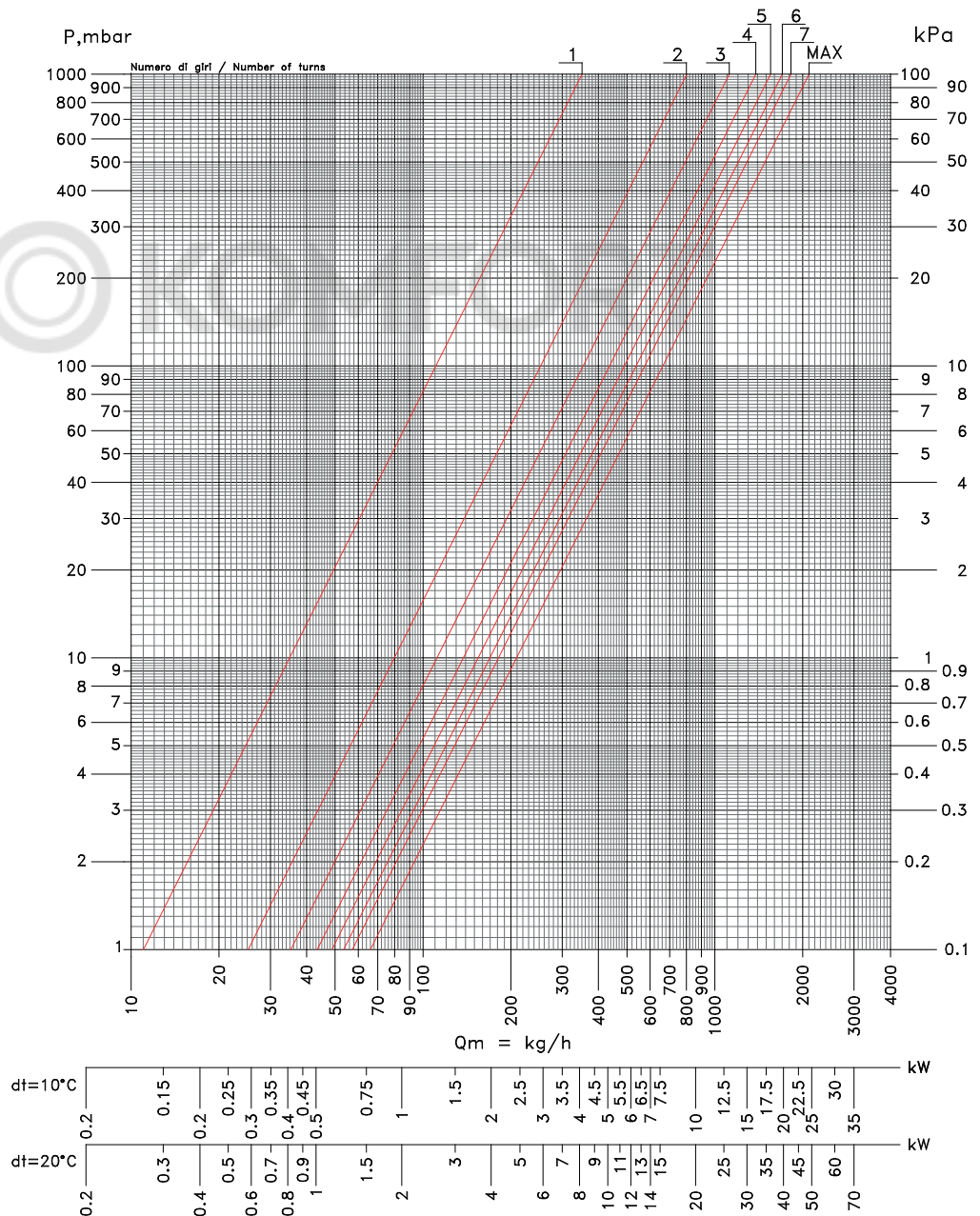

**Note:** To avoid excessive noisiness in the circuit, avoid using thermostatic valves with  $\Delta p$  values of more than 0,2 - 0,25 bar [20-25 kPa].

## DESIGN RADIATOR VALVES TWIN SERIES

### Hydraulic characteristics:

**V425**  
**V427**  
**V375**  
**V377**  
**V42506**  
Straight valve  
DN15 1/2"

Pre-setting	Kv
N	m <sup>3</sup> /h
	1.45
	1.70
	1.80
	1.90
	1.92
	1.94
	1.96
<b>Kvs</b>	<b>m<sup>3</sup>/h</b>
	2.00

The diagrams show the values of the valve head losses in the different preset positions. For each of them is shown the corresponding Kv values.

TWIN PRESET MONOTUBE  
STRAIGHT DN 15 1/2"

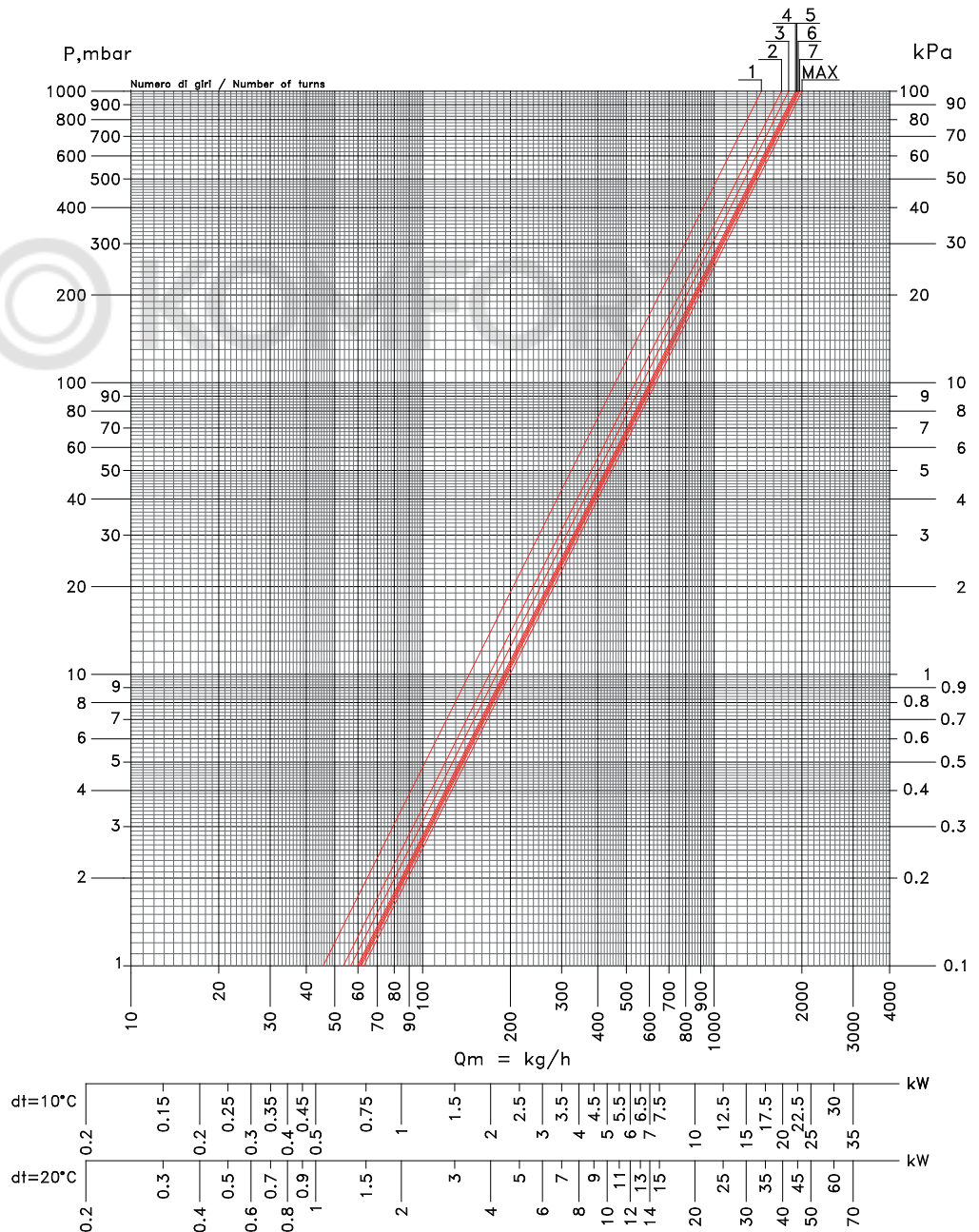

**Note:** To avoid excessive noisiness in the circuit, avoid using thermostatic valves with  $\Delta p$  values of more than 0,2 - 0,25 bar [20-25 kPa].

## DESIGN RADIATOR VALVES TWIN SERIES

### Hydraulic characteristics:

**V421 V423**  
**V371 V373**  
**V42106**  
Angle valve  
DN15 1/2"

#### Technical data

Kv	1K	0.44
	2K	0.89
Kvs	2.05	
Q <sub>mN</sub>	kg/h	281.32

Pressure loss diagrams are made with position 3 of the thermostatic head and the difference between ambient and preset temperature of 1K (diagram S-1K), 2K (diagram S-2K) and with fully open valve.

TWIN THERMO BITUBE  
ANGLE DN 15 1/2"

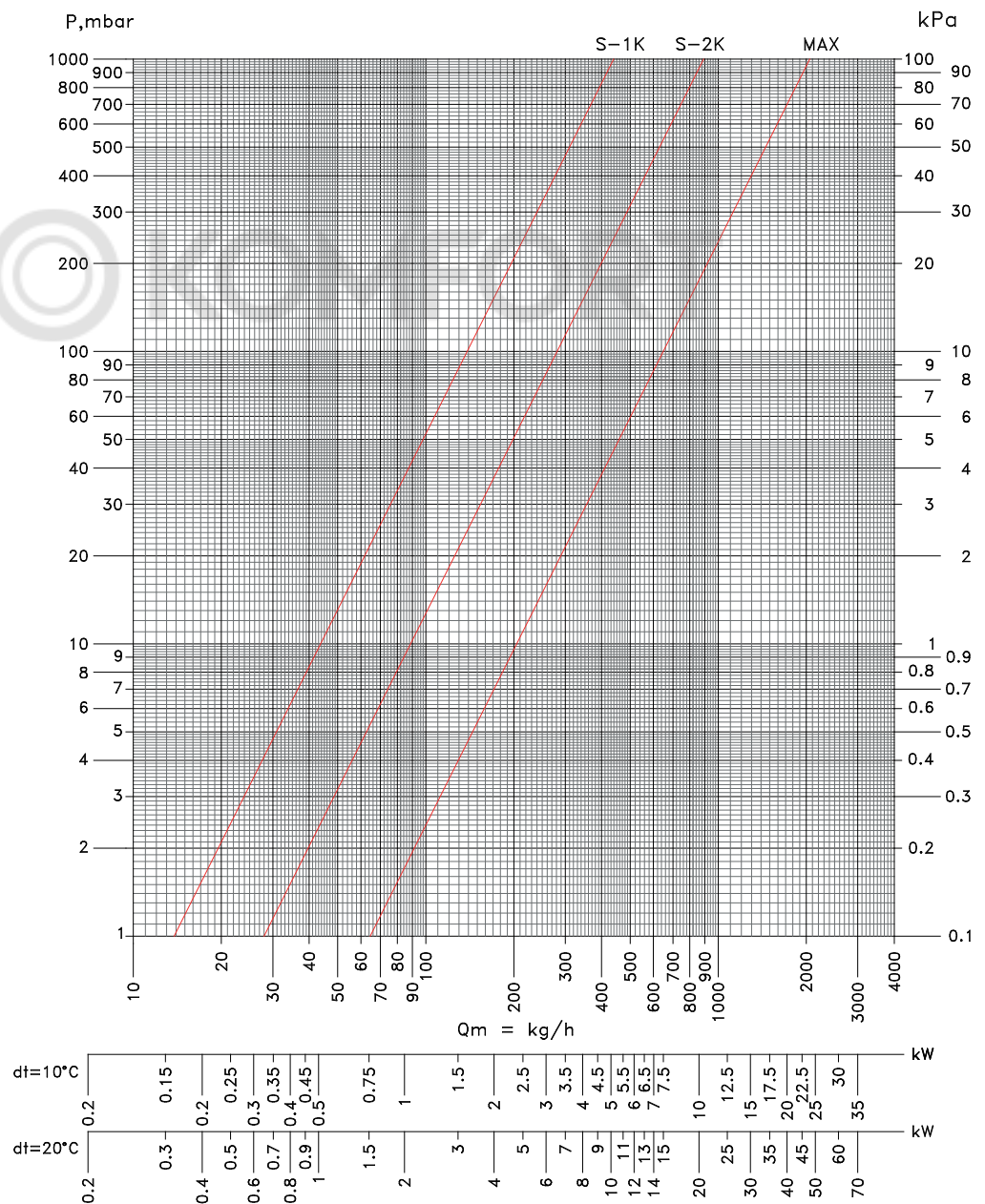

**Note:** To avoid excessive noisiness in the circuit, avoid using thermostatic valves with  $\Delta p$  values of more than 0,2 - 0,25 bar [20-25 kPa].

## DESIGN RADIATOR VALVES TWIN SERIES

### Hydraulic characteristics:

**V425 V427**  
**V375 V377**  
**V42506**  
Straight valve  
DN15 1/2"

Technical data		
Kv	1K	0.52
	2K	0.91
	Kvs	2.00
Q <sub>mN</sub>	kg/h	287.05

Pressure loss diagrams are made with position 3 of the thermostatic head and the difference between ambient and preset temperature of 1K (diagram S-1K), 2K (diagram S-2K) and with fully open valve.

TWIN THERMO BITUBE  
STRAIGHT DN 15 1/2"

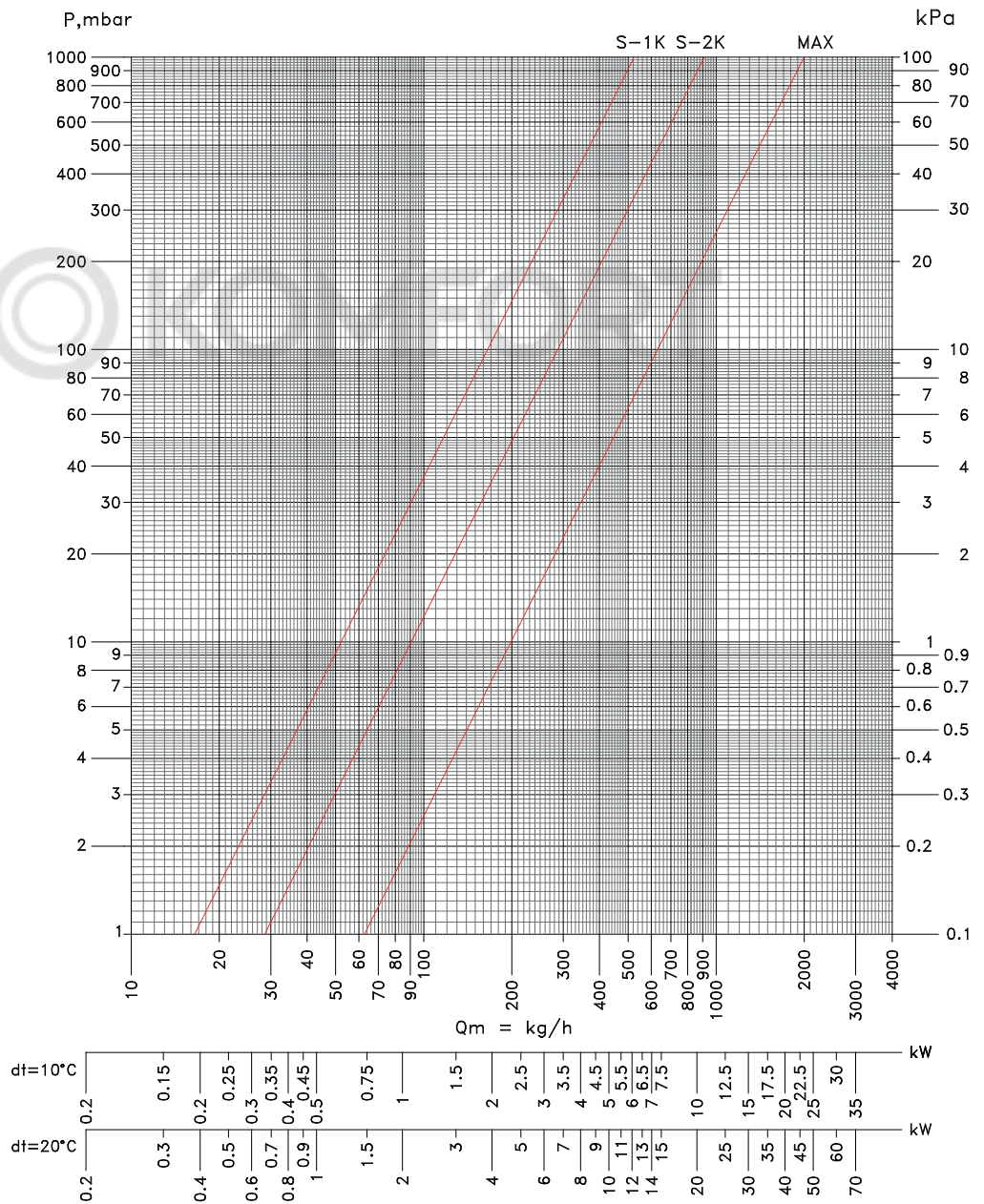

**Note:** To avoid excessive noisiness in the circuit, avoid using thermostatic valves with Δp values of more than 0,2 - 0,25 bar [20-25 kPa].



## DESIGN RADIATOR VALVES TWIN SERIES

### Hydraulic characteristics:

**V421 V423  
V371 V373  
V42106**  
Angle valve  
DN15 1/2"

Number of turns	Kv
N	m <sup>3</sup> /h
1	0.32
1.5	0.56
2	0.92
2.5	1.42
3	1.66
3.5	1.97
4	2.18
<b>Kvs</b>	<b>2.36</b>

The positions are determined with the number of opening turns of the valve from the fully closed position.

TWIN LOCKSHIELD BITUBE  
ANGLE DN 15 1/2"

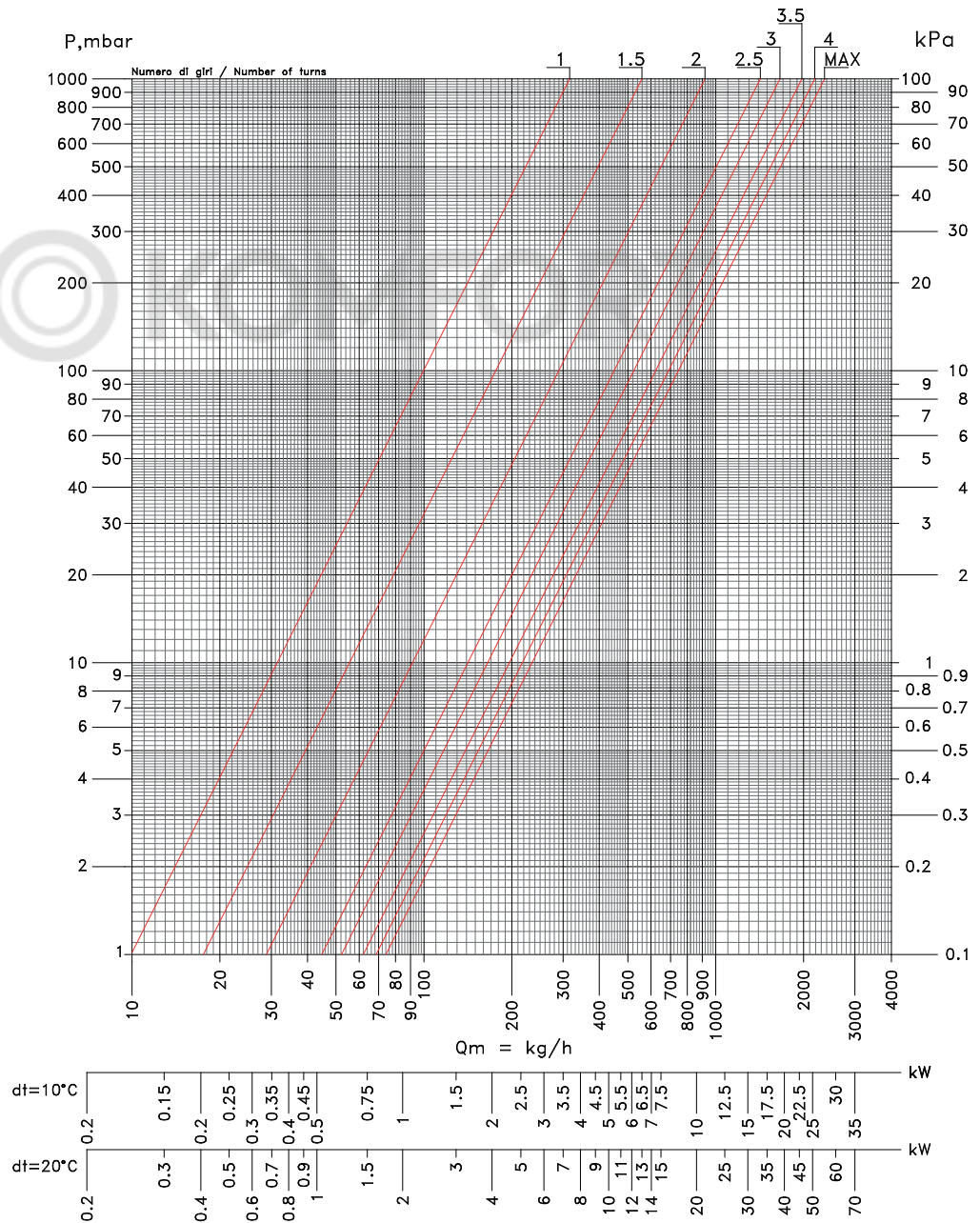

## DESIGN RADIATOR VALVES TWIN SERIES

### Hydraulic characteristics:

**V421 V423**  
**V371 V373**  
**V42106**  
Angle valve  
DN15 1/2"

Number of turns	Kv
N	m <sup>3</sup> /h
1	1.46
1.5	1.55
2	1.62
2.5	1.76
3	1.90
3.5	1.98
4	2.03
<b>Kvs</b>	<b>2.10</b>

The positions are determined with the number of opening turns of the valve from the fully closed position.

TWIN LOCKSHIELD MONOTUBE  
ANGLE DN 15 1/2"

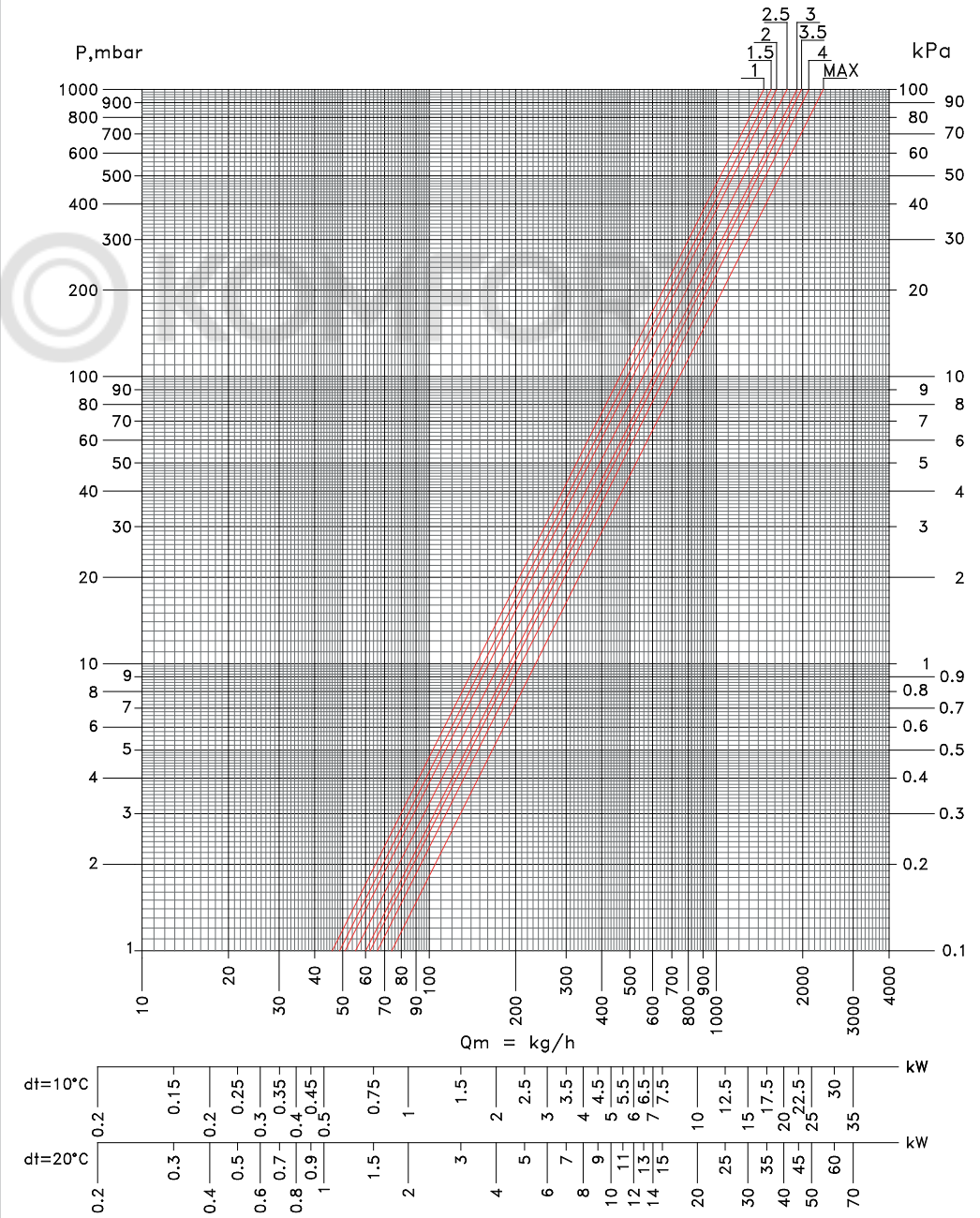



## DESIGN RADIATOR VALVES TWIN SERIES

### Hydraulic characteristics:

**V425 V427**  
**V375 V377**  
**V42506**  
Straight valve  
DN15 1/2"

Number of turns	Kv
N	m <sup>3</sup> /h
1	0.28
1.5	0.58
2	1.00
2.5	1.62
3	1.75
3.5	1.95
4	2.00
<b>Kvs</b>	<b>2.10</b>

The positions are determined with the number of opening turns of the valve from the fully closed position.

TWIN LOCKSHIELD BITUBE  
STRAIGHT DN 15 1/2"

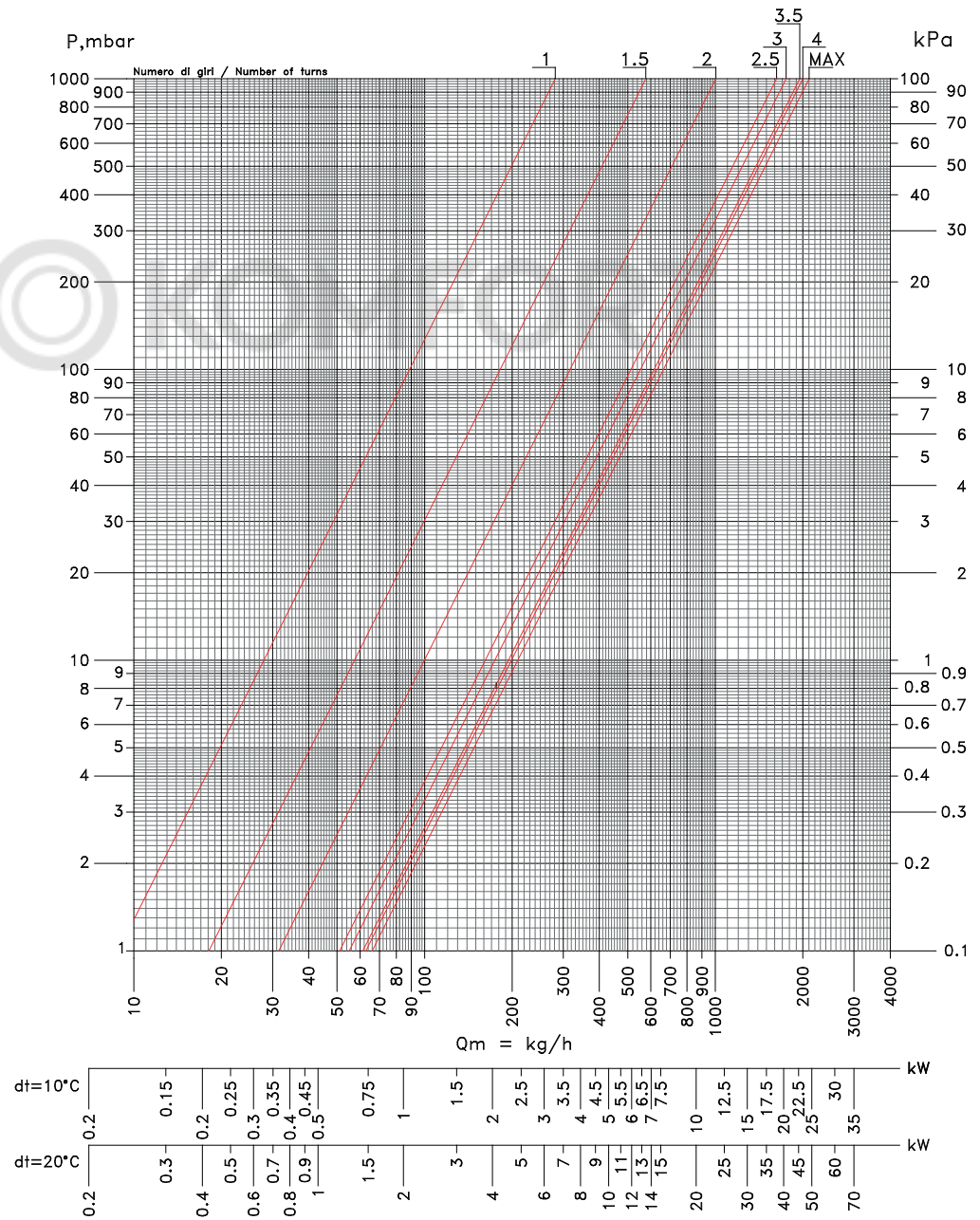

## DESIGN RADIATOR VALVES TWIN SERIES

### Hydraulic characteristics:

**V425 V427**  
**V375 V377**  
**V42506**  
Straight valve  
DN15 1/2"

Number of turns	Kv
N	m <sup>3</sup> /h
1	0.32
1.5	0.57
2	0.95
2.5	1.40
3	1.52
3.5	1.61
4	1.70
<b>Kvs</b>	<b>1.75</b>

The positions are determined with the number of opening turns of the valve from the fully closed position.

TWIN LOCKSHIELD MONOTUBE  
STRAIGHT DN 15 1/2"

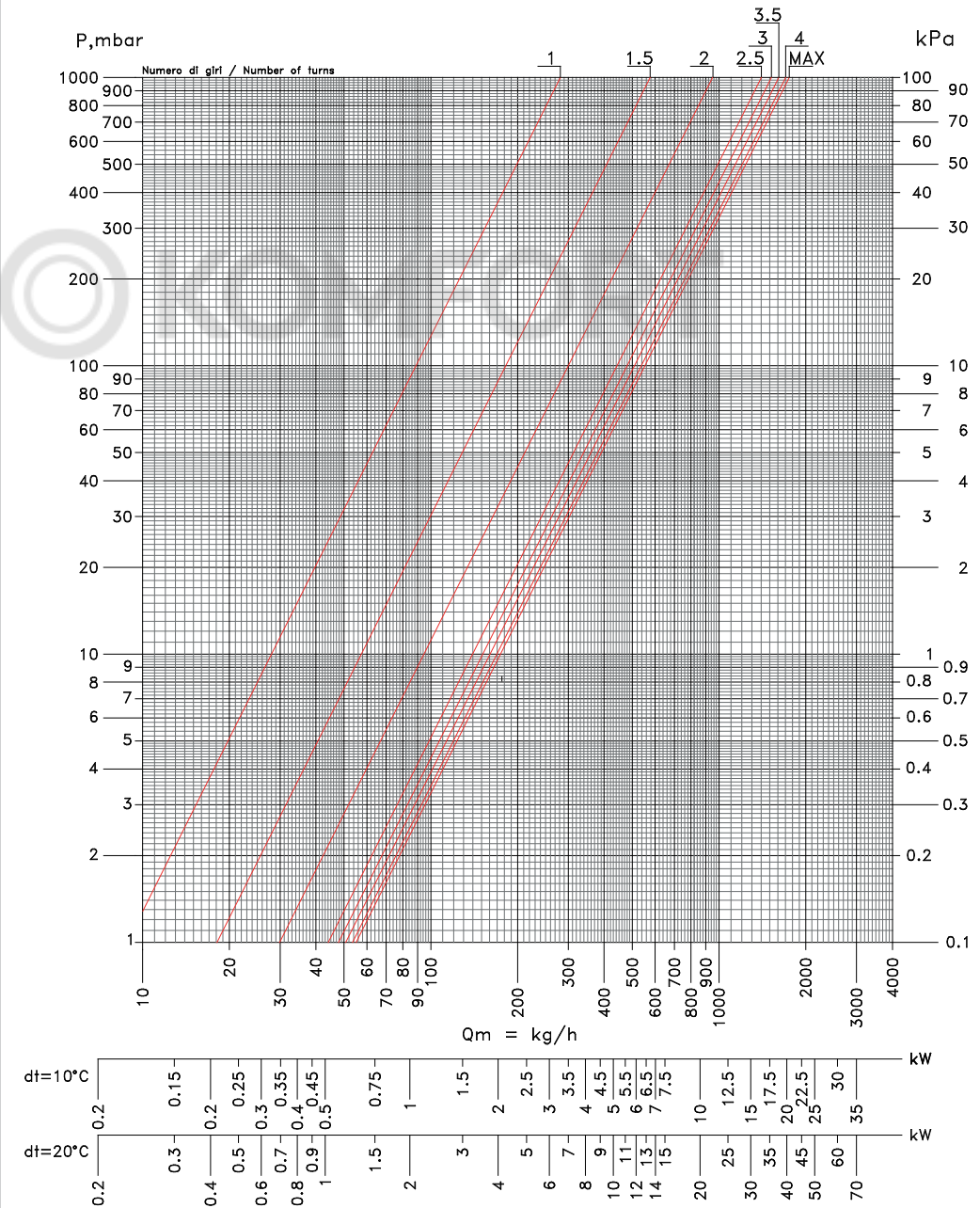

## DESIGN RADIATOR VALVES TWIN SERIES

### Example:

Determination of preset of the valve:

Given data	
Type of valve	V371PS DN15 1/2"
Heat flow of radiator	2150 W
Temperature difference	20 °C
Differential pressure across the radiator	4 kPa

The mass flow is calculated using the following relation:

$$Q_m = \frac{Q}{c * \Delta t} = \frac{2150}{1,163 * 20} = 92 \text{ kg/h}$$

Alternatively, it is possible to use the graduated scale of the selected valve diagram that provides the flow rate according to the design dT. It is possible to determine the required pre-setting as shown in the example alongside where it is equal to 1.5.

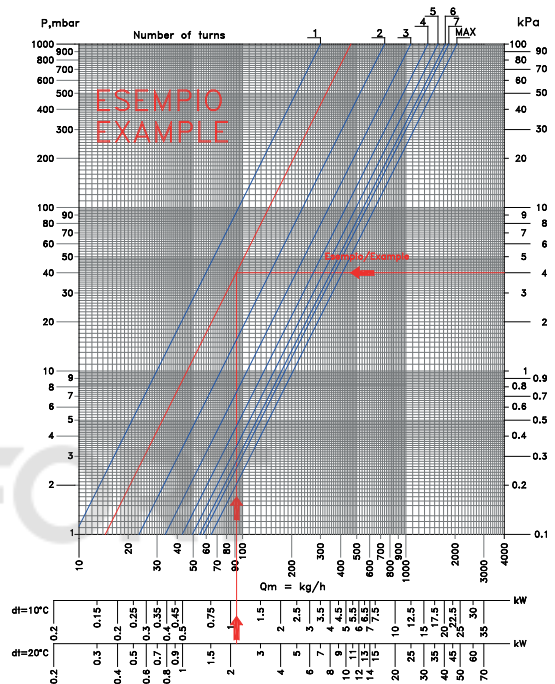

Determination of valve pressure loss:

Given data	
Type of valve	V375 DN15 1/2"
Heat flow of radiator	2150 W
Temperature difference	20 °C
Desired proportional band	2K

The mass flow is calculated using the following relation:

$$Q_m = \frac{Q}{c * \Delta t} = \frac{2150}{1,163 * 20} = 92 \text{ kg/h}$$

Alternatively, it is possible to use the graduated scale of the selected valve diagram that provides the flow rate according to the design dT.

It is possible to determine the head losses value for the proportional band chosen as shown in the example alongside where it is equal to 1.1 kPa.

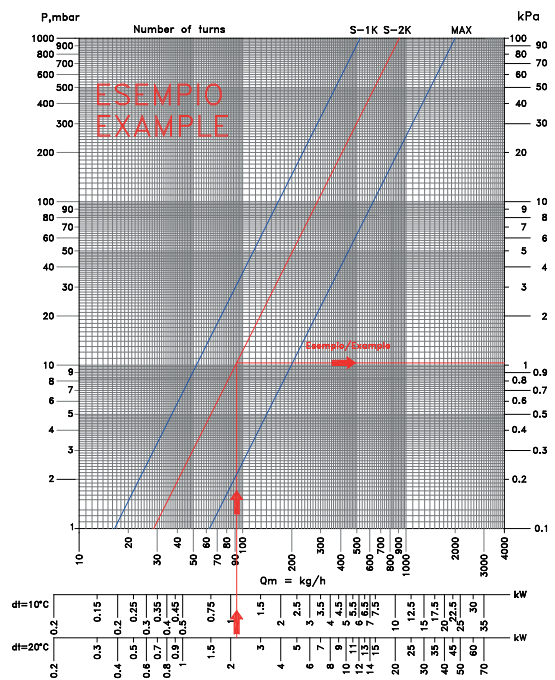

## SPECIFICATION SUMMARIES

### **V421 MODEL**

Thermostatic mono/bitube angle H valve with manual handle for copper or plastic pipe. The single valve body contains both elements: thermostatic valve and lockshield valve. Distance between connections 50 mm. Connection for thermostatic head M30x1,5. Valve body made of color finishing brass. Control stem made of stainless steel with EPDM peroxide O-Ring. Manual control of lockshield valve with shutter under the cap. Connection to radiator with tailpeace 1/2"M. Maximum working pressure 10 bar. Temperature range of liquid medium from 5 to 110 °C.

### **V425 MODEL**

Thermostatic mono/bitube straight H valve with manual handle for copper or plastic pipe. The single valve body contains both elements: thermostatic valve and lockshield valve. Distance between connections 50 mm. Connection for thermostatic head M30x1,5. Valve body made of color finishing brass. Control stem made of stainless steel with EPDM peroxide O-Ring. Manual control of lockshield valve with shutter under the cap. Connection to radiator with tailpeace 1/2"M. Maximum working pressure 10 bar. Temperature range of liquid medium from 5 to 110 °C.

### **V371 MODEL**

Thermostatic mono/bitube angle H valve with plastic protecton cap for copper or plastic pipe. The single valve body contains both elements: thermostatic valve and lockshield valve. Distance between connections 50 mm. Connection for thermostatic head M30x1,5. Valve body made of color finishing brass. Control stem made of stainless steel with EPDM peroxide O-Ring. Manual control of lockshield valve with shutter under the cap. Connection to radiator with tailpeace 1/2"M. Maximum working pressure 10 bar. Temperature range of liquid medium from 5 to 110 °C.

### **V375 MODEL**

Thermostatic mono/bitube straight H valve with plastic protecton cap for copper or plastic pipe. The single valve body contains both elements: thermostatic valve and lockshield valve. Distance between connections 50 mm. Connection for thermostatic head M30x1,5. Valve body made of color finishing brass. Control stem made of stainless steel with EPDM peroxide O-Ring. Manual control of lockshield valve with shutter under the cap. Connection to radiator with tailpeace 1/2"M. Maximum working pressure 10 bar. Temperature range of liquid medium from 5 to 110 °C.

### **V481 MODEL**

Lockshield mono/bitube angle H valve with brass cap for copper or plastic pipe. The single valve body contains double lockshield elements. Distance between connections 50 mm. Valve body made of color finishing brass. Manual control of lockshield valve with shutter under the cap. Connection to radiator with tailpeace 1/2"M. Maximum working pressure 10 bar. Temperature range of liquid medium from 5 to 110 °C.

### **V485 MODEL**

Lockshield mono/bitube straight H valve with brass cap for copper or plastic pipe. The single valve body contains double lockshield elements. Distance between connections 50 mm. Valve body made of color finishing brass. Manual control of lockshield valve with shutter under the cap. Connection to radiator with tailpeace 1/2"M. Maximum working pressure 10 bar. Temperature range of liquid medium from 5 to 110 °C.



## SPECIFICATION SUMMARIES

### **V423 MODEL**

Thermostatic mono/bitube angle H valve with manual handle for copper or plastic pipe. The single valve body contains both elements: thermostatic valve and lockshield valve. Distance between connections 50 mm. Connection for thermostatic head M30x1,5. Valve body made of brass with color finishing. Control stem made of stainless steel with EPDM peroxide O-Ring. Manual control of lockshield valve with shutter under the cap. Connection to radiator with tailpeace 3/4"F. Maximum working pressure 10 bar. Temperature range of liquid medium from 5 to 110 °C.

### **V427 MODEL**

Thermostatic mono/bitube straight H valve with manual handle for copper or plastic pipe. The single valve body contains both elements: thermostatic valve and lockshield valve. Distance between connections 50 mm. Connection for thermostatic head M30x1,5. Valve body made of brass with color finishing. Control stem made of stainless steel with EPDM peroxide O-Ring. Manual control of lockshield valve with shutter under the cap. Connection to radiator with tailpeace 3/4"F. Maximum working pressure 10 bar. Temperature range of liquid medium from 5 to 110 °C.

### **V373 MODEL**

Thermostatic mono/bitube angle H valve with plastic protecton cap for copper or plastic pipe. The single valve body contains both elements: thermostatic valve and lockshield valve. Distance between connections 50 mm. Connection for thermostatic head M30x1,5. Valve body made of brass with color finishing. Control stem made of stainless steel with EPDM peroxide O-Ring. Manual control of lockshield valve with shutter under the cap. Connection to radiator with tailpeace 3/4"F. Maximum working pressure 10 bar. Temperature range of liquid medium from 5 to 110 °C.

### **V377 MODEL**

Thermostatic mono/bitube straight H valve with plastic protecton cap for copper or plastic pipe. The single valve body contains both elements: thermostatic valve and lockshield valve. Distance between connections 50 mm. Connection for thermostatic head M30x1,5. Valve body made of brass with color finishing. Control stem made of stainless steel with EPDM peroxide O-Ring. Manual control of lockshield valve with shutter under the cap. Connection to radiator with tailpeace 3/4"F. Maximum working pressure 10 bar. Temperature range of liquid medium from 5 to 110 °C.

### **V483 MODEL**

Lockshield mono/bitube angle H valve with brass cap for copper or plastic pipe. The single valve body contains double lockshield elements. Distance between connections 50 mm. Connection for thermostatic head M30x1,5. Valve body made of brass with color finishing. Manual control of lockshield valve with shutter under the cap. Connection to radiator with tailpeace 3/4"F. Maximum working pressure 10 bar. Temperature range of liquid medium from 5 to 110 °C.

### **V487 MODEL**

Lockshield mono/bitube straight H valve with brass cap for copper or plastic pipe. The single valve body contains double lockshield. Distance between connections 50 mm. Connection for thermostatic head M30x1,5. Valve body made of brass with color finishing. Manual control of lockshield valve with shutter under the cap. Connection to radiator with tailpeace 3/4"F. Maximum working pressure 10 bar. Temperature range of liquid medium from 5 to 110 °C.

**CARLO POLETTI**

HeatingComponents&amp;Design

**V42106 MODEL**

Thermostatic mono/bitube angle H valve with brass manual handle for copper or plastic pipe. The single valve body contains both elements: thermostatic valve and lockshield valve. Distance between connections 50 mm. Connection for thermostatic head M24x1,5. Valve body made of color finishing brass. Control stem made of stainless steel with EPDM peroxide O-Ring. Manual control of lockshield valve with shutter under the cap. Connection to radiator with tailpiece 1/2"M. Maximum working pressure 10 bar. Temperature range of liquid medium from 5 to 110 °C.

**V42506 MODEL**

Thermostatic mono/bitube straight H valve with brass manual handle for copper or plastic pipe. The single valve body contains both elements: thermostatic valve and lockshield valve. Distance between connections 50 mm. Connection for thermostatic head M24x1,5. Valve body made of color finishing brass. Control stem made of stainless steel with EPDM peroxide O-Ring. Manual control of lockshield valve with shutter under the cap. Connection to radiator with tailpiece 1/2"M. Maximum working pressure 10 bar. Temperature range of liquid medium from 5 to 110 °C.

Company Carlo Poletti S.r.l. reserves the right to change the product line and corresponding technical data at any time and without any notification.

Carlo Poletti srl  
Sede legale/Registered office:  
Via Tancognino, 134  
28024 Gozzano (NO) Italy  
P.IVA/VAT: IT00127430031

Stabilimento e uffici/Production and offices:  
Via Martiri delle Foibe, 15  
28024 Gozzano (NO) Italy  
Tel. +39 0322 94752 / 913699  
Fax +39 0322 956577  
info@poletti.it - www.poletti.it

  
QUALITY MADE IN ITALY