



Room temperature controller with 24-hour time switch and large LCD

RDJ10

For heating systems

- **Operating modes: Automatic, Comfort, Energy Saving, and Frost Protection**
- **Large LCD**
- **Battery-powered: 2 x alkaline type AA batteries, 1.5 V**

Use

The RDJ10 is used to control the room temperature in heating systems.

Typical applications:

- Homes
- Residential buildings
- Schools
- Offices

The controller is used together with the following equipment:

- Thermal valves or zone valves
- Combi boilers
- Gas or oil burners
- Fans
- Pumps

Functions

The controller acquires the room temperature with its integrated sensor.

Function diagram

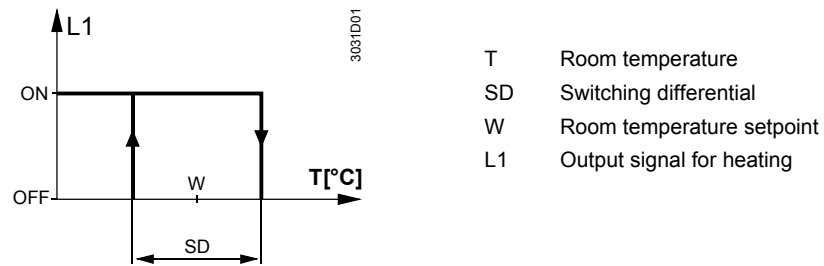

Temperature sensor

The RDJ10 provides room temperature control only.

Operating modes

The RDJ10 provides the following modes: Automatic, Comfort, Energy Saving and Frost Protection.

Changeover between the operating modes is made by moving the operating mode slider to the respective position.

Automatic mode

When Automatic mode is active, symbol  appears on the display. The RDJ10 operates according to the selected 24-hour time program.

Comfort mode

When Comfort mode is active, symbol  appears on the display. The RDJ10 controls to the temperature setpoint adjusted at T_{gear} . This setpoint can be readjusted by setting the programming slider to T_{gear} .

Energy Saving mode

When Energy Saving mode is active, symbol  appears on the display. The RDJ10 controls to the temperature setpoint adjusted at T_{C} . This setpoint can be readjusted by setting the programming slider to T_{C} .

Frost Protection

When Frost Protection is active, symbol  appears on the display. The RDJ10 controls to the fixed temperature setpoint for frost protection.

Display

The digital display shows the actual room temperature, the ON / OFF times and the symbol of the operating mode currently active. When the heating output is active, the triangle symbol appears.

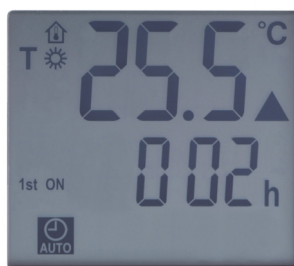

Backup

When taking out the batteries, the setpoints and the information required for operating mode changeover are retained for maximum 2 minutes.

Ordering

When ordering, please give name and product number: Room temperature controller RDJ10.

Valves and actuators are to be ordered as separate items.

Equipment combinations

Type of unit	Product number	Data sheet
Electromotoric actuator	SFA21...	4863
Electrothermal actuator (for radiator valves)	STA21...	4877
Electrothermal actuator (for small valves 2.5 mm)	STP21...	4878
2- or 3-port zone valve	MXI/MVI421...	4867
Electromotoric actuator for zone valves V..146..	SUA21	4830
Electric actuator	SUA11/22	4832
Air damper actuator	GDB...	4624
Air damper actuator	GSD/GQD...	4606
Air damper actuator	GXD...	4622

Mechanical design

The controller consists of 3 parts:

- Plastic housing with digital display accommodating the electronics, operating elements and built-in room temperature sensor
- Baseplate (mounting base)
- Removable battery compartment

The housing engages in the baseplate and snaps on. The baseplate carries the screw terminals. There is a reset button on the rear of the unit.

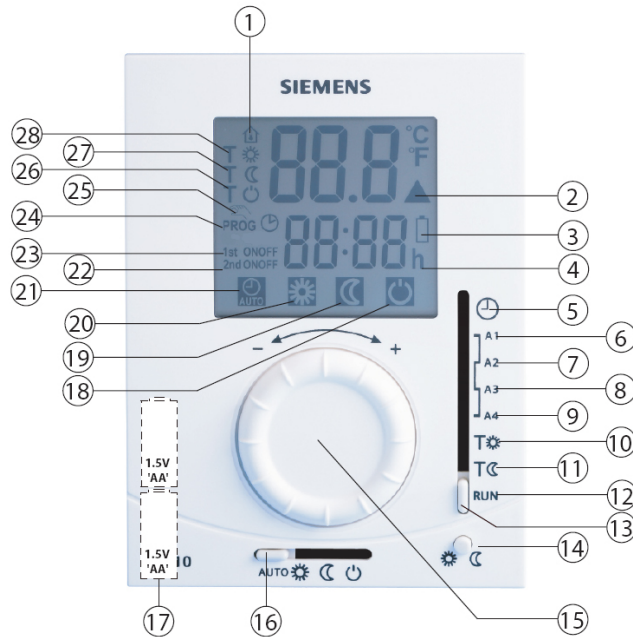

Key

- 1 Display of the room temperature in °C
- 2 Indicates a request for heat
- 3 Indicates low battery power; replace batteries
- 4 Time of day (00:00...23:59 format)
- 5 Time setting position
- 6 First switch ON time
- 7 First switch OFF time
- 8 Second switch ON time
- 9 Second switch OFF time
- 10 Comfort temperature setting
- 11 Energy saving temperature setting
- 12 RUN position
- 13 Programming slider
- 14 Advance button (override / presence button)
- 15 Temperature setting knob
- 16 Operating mode slider
- 17 Battery compartment
- 18 Frost Protection; the RDJ10 controls to the fixed temperature setpoint for frost protection
- 19 Energy Saving mode; the RDJ10 controls continuously to the energy saving temperature setpoint
- 20 Comfort mode; the RDJ10 controls continuously to the comfort temperature setpoint
- 21 Automatic mode; the RDJ10 operates according to the selected time and temperature program
- 22 Indicates second switch ON / OFF time
- 23 Indicates first switch ON / OFF time
- 24 Indicates that programming is taking place
- 25 Setpoint is overridden temporarily (by advance button) until the next switching time
- 26 The RDJ10 controls to the fixed frost protection temperature setpoint
- 27 The RDJ10 controls to the adjusted energy saving temperature setpoint
- 28 The RDJ10 controls to the adjusted comfort temperature setpoint

Notes

Mount the room temperature controller in a location where the air temperature can be acquired as accurately as possible without getting adversely affected by direct solar radiation or other heat or refrigeration sources.

Mounting height is about 1.5 m above the floor.

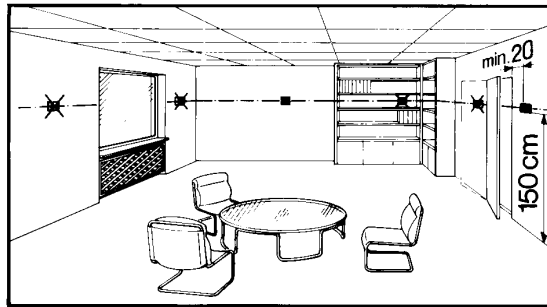

The unit can be fitted to a recessed conduit box.

Mounting, installation and commissioning

When mounting the unit, fix the baseplate first. Then, make the electrical connections and fit and secure the controller (also refer to separate mounting instructions).

Mount the controller on a flat wall and in compliance with local regulations.

If there are thermostatic radiator valves in the reference room, set them to their fully open position.

Maintenance

The controller is maintenance-free.

Change of batteries



If the battery symbol  appears, the batteries are almost exhausted and must be replaced.

Reset

To reset, press the reset button on the rear of the unit. All individual settings are then reset to their default values.

Technical data

Power supply	Operating voltage	DC 3 V (2 x 1.5 V AA alkaline batteries)
	Battery life	>1 year (with AA alkaline batteries)
Sensor inputs	Internal:	
	Thermistor	10 kΩ ± 1% at 25 °C
Outputs	Relay contacts	
 Switching outputs (LX, L1, L2)	Switching voltage	Max. AC 250 V Min. AC 24 V
	Switching current	Max. 5 A res., 2 A ind. Min. 200 mA
	Contact life at AC 250 V	Guide value: 1 x 10 ⁵ cycles
	Insulating strength	
		Between relay contacts and coil
	Between relay contacts (same pole)	AC 1,000 V
Operational data	Switching differential SD	1 K
	Setpoint setting range	5...30 °C (Comfort mode) 5...30 °C (Energy Saving mode) 5 °C (Frost Protection, fixed value)
	Factory setting for Comfort mode	20 °C
	Factory setting for Energy Saving mode	10 °C

	Resolution of settings and displays	
	Temperature setpoints	0.5 °C
	Display of actual temperature value	0.5 °C
	Display of time of day	1 min
Electrical connections	Connection terminals (via mounting plate)	Screw terminals
	For solid wires	2 x 1.5 mm ²
	For stranded wires	1 x 2.5 mm ² (min. 0.5 mm ²)
Environmental conditions	Operation	To IEC 721-3-3
	Climatic conditions	Class 3K5
	Temperature	0...+40 °C
	Humidity	<90% r.h.
	Transport	To IEC 721-3-2
	Climatic conditions	Class 2K3
	Temperature	-25...+60 °C
	Humidity	<95% r.h.
	Mechanical conditions	Class 2M2
	Storage	To IEC 721-3-1
	Climatic conditions	Class 1K3
	Temperature	-10...+60 °C
	Humidity	<90% r.h.
Standards	 conformity to	
	EMC directive	2004/108/EC
	Low-voltage directive	2006/95/EC
	 ^{N474} C-tick conformity to	
	Test standards and requirements	EN 61000-6-3, AS/NZS 4251.1:1999
	Product standards	
	Automatic electrical controls for household and similar use	EN 60730- 1 and EN 60730- 2-9
	Information technology equipment-Safety-General Requirements	EN 60950-1
	Generic standards-Compliance to lower power electronic apparatus	EN 50371-1
	Safety class	II to EN 60730
	Pollution degree	2
	Degree of protection of housing	IP20
General	Weight (including packaging)	
	RDJ10	340 g
	Color of housing front	Signal-white RAL 9003
	Housing material	ABS (LCD lens: PC)

Connection diagram

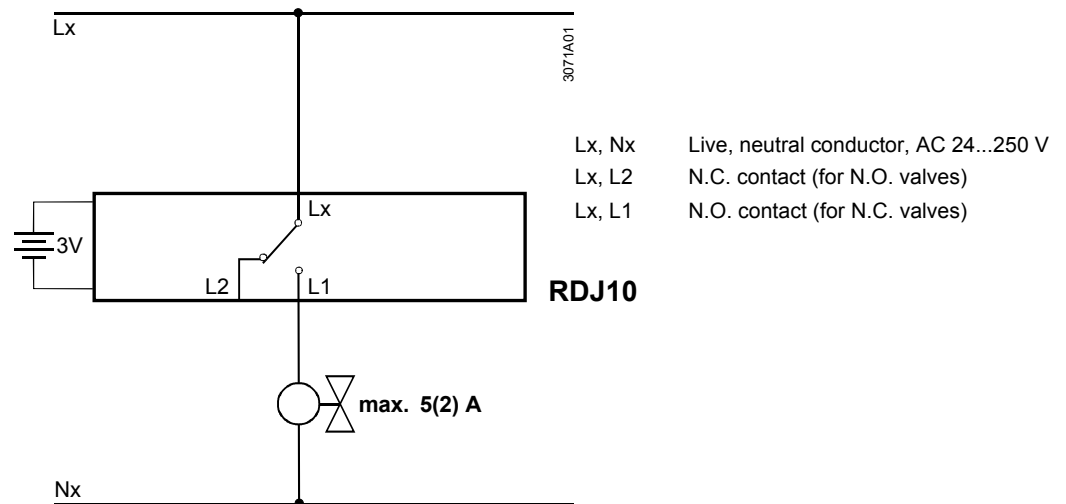

Application examples

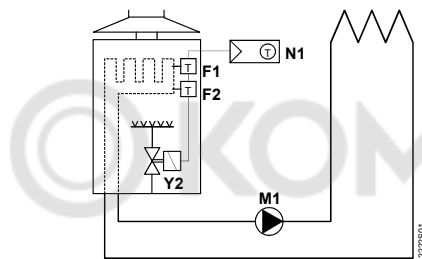

Room temperature controller with direct control of a gas-fired wall-hung boiler

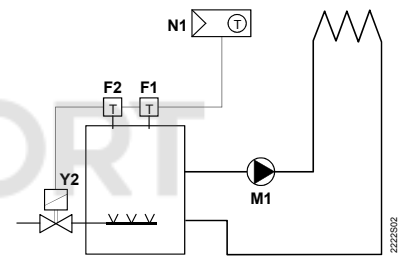

Room temperature controller with direct control of a gas-fired floor-standing boiler

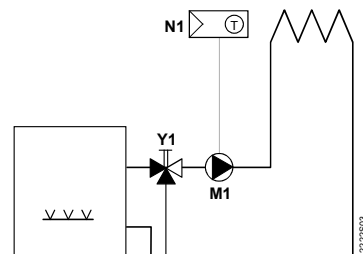

Room temperature controller with direct control of a heating circuit pump (precontrol by manual mixing valve)

F1	Thermal reset limit thermostat	N1	Room temperatures controller RDJ10
F2	Safety limit thermostat	Y1	3-port valve with manual adjustment
M1	Circulating pump	Y2	Magnetic valve

Dimensions

Room temperature controller

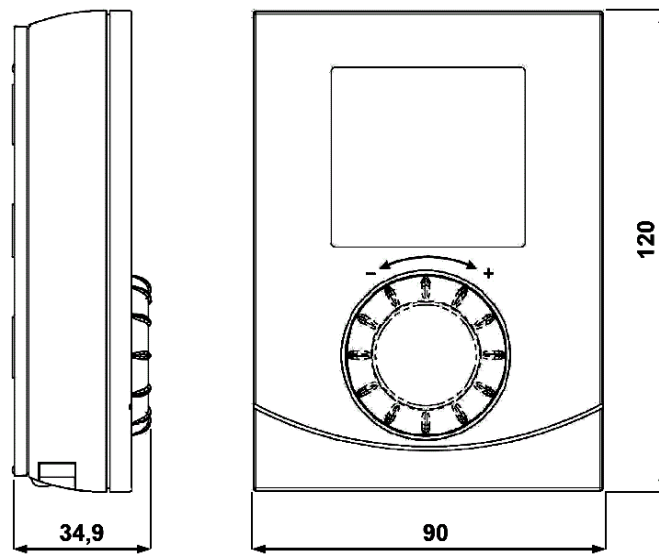

Baseplate

