

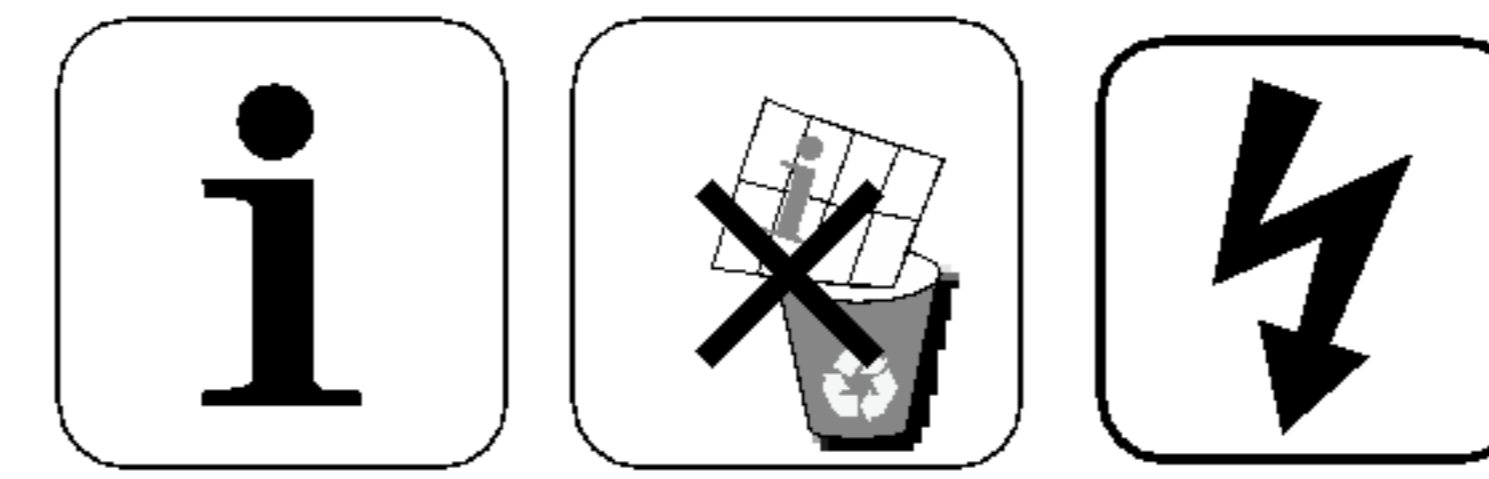

www.esbe.se

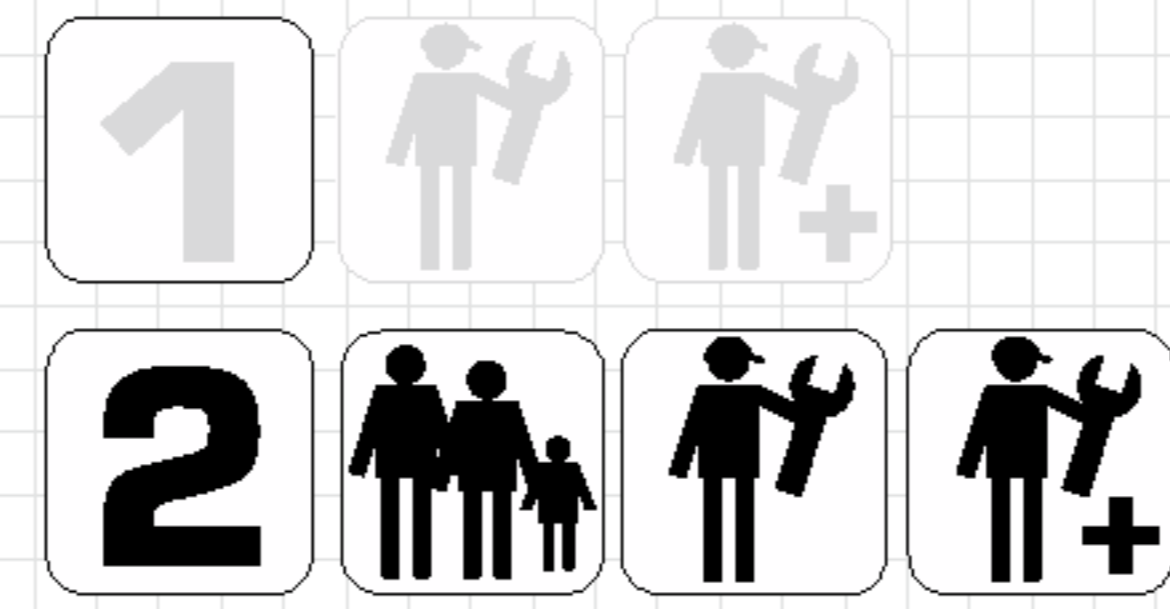

Series CRA111  
Series CRA112

CE

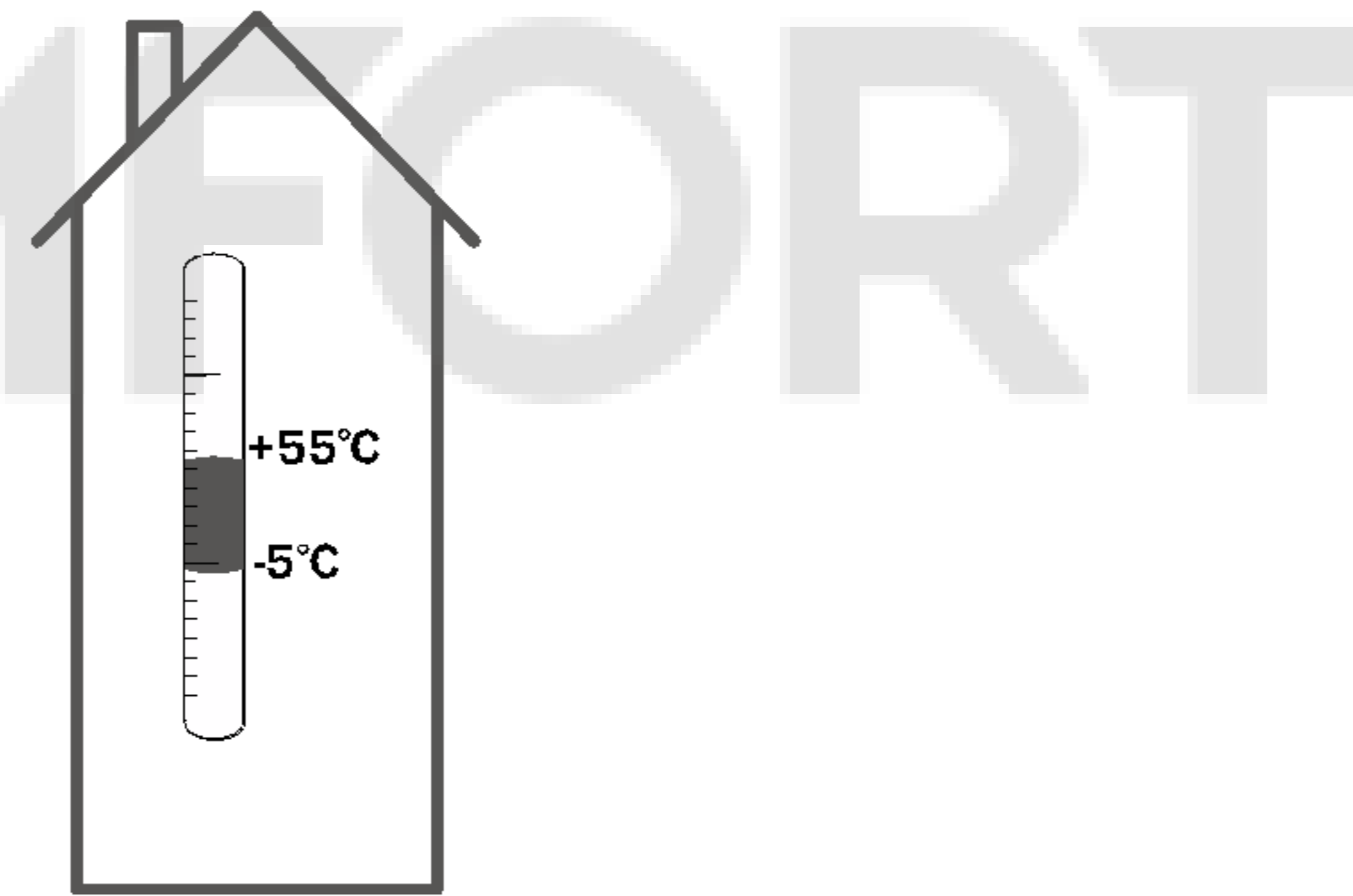

NO.1 IN HYDRONIC SYSTEM CONTROL

Mtrl.nr. 9814 03 90 • Ritn.nr. 9210 utg. B • Rev. 1012

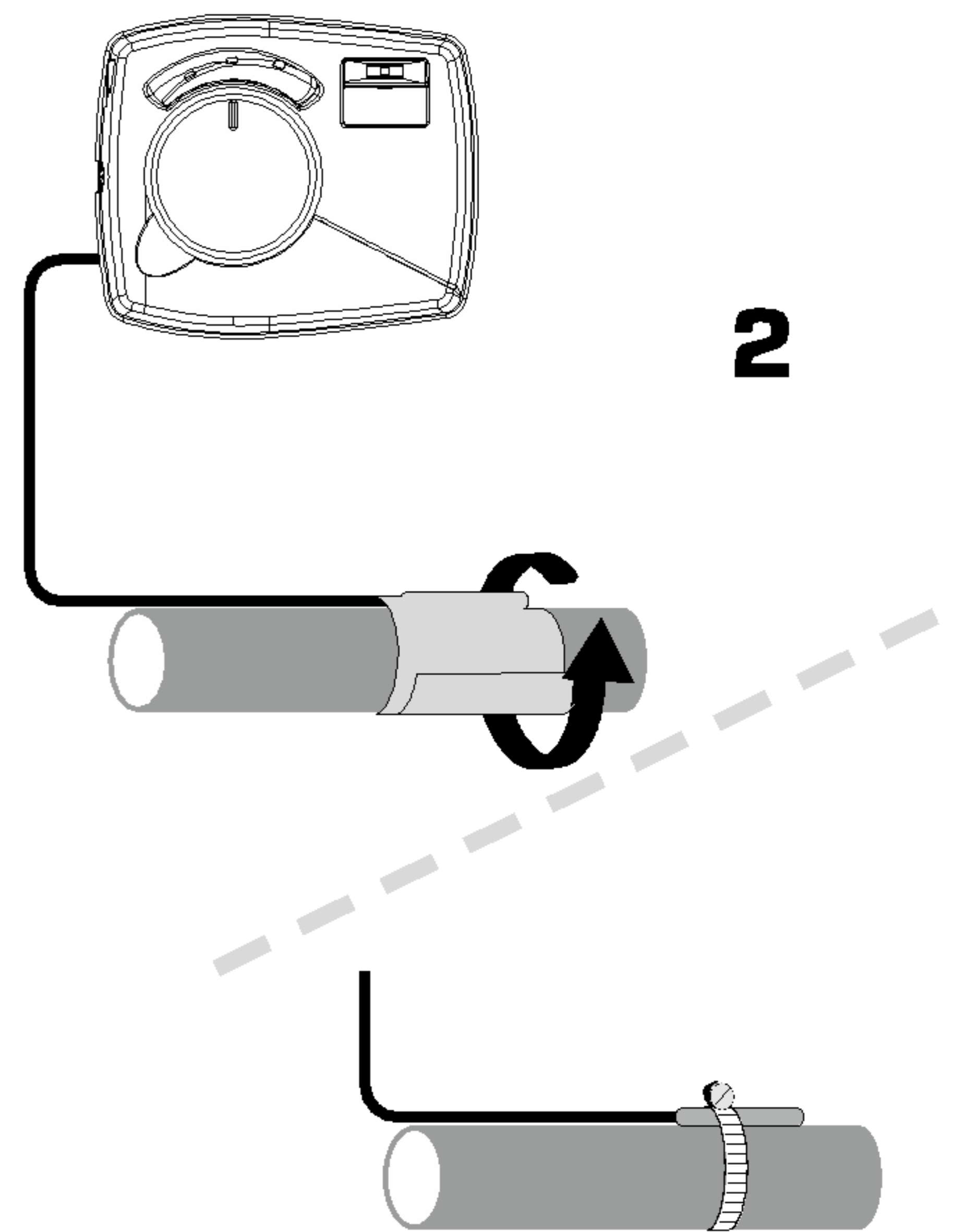
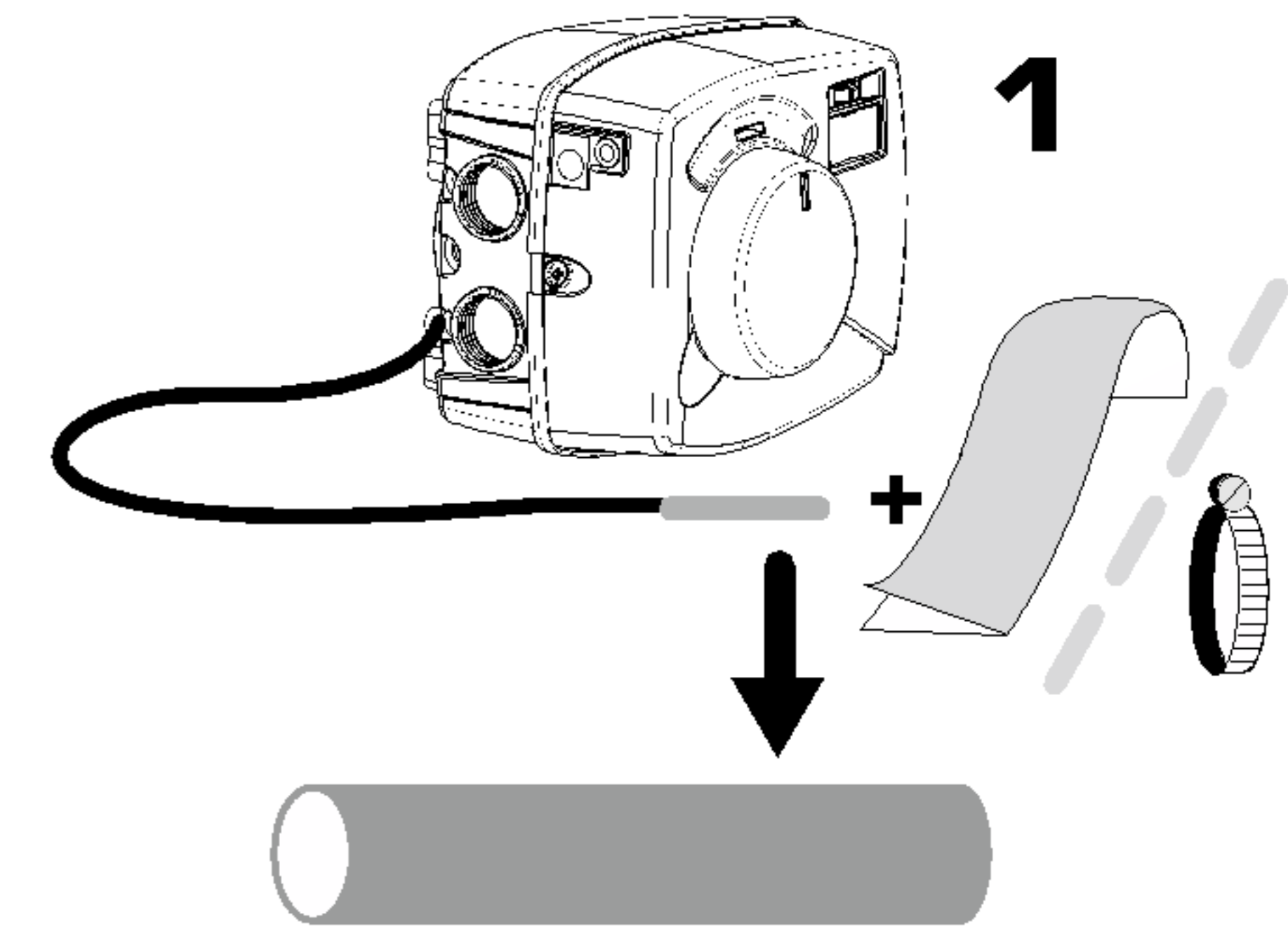
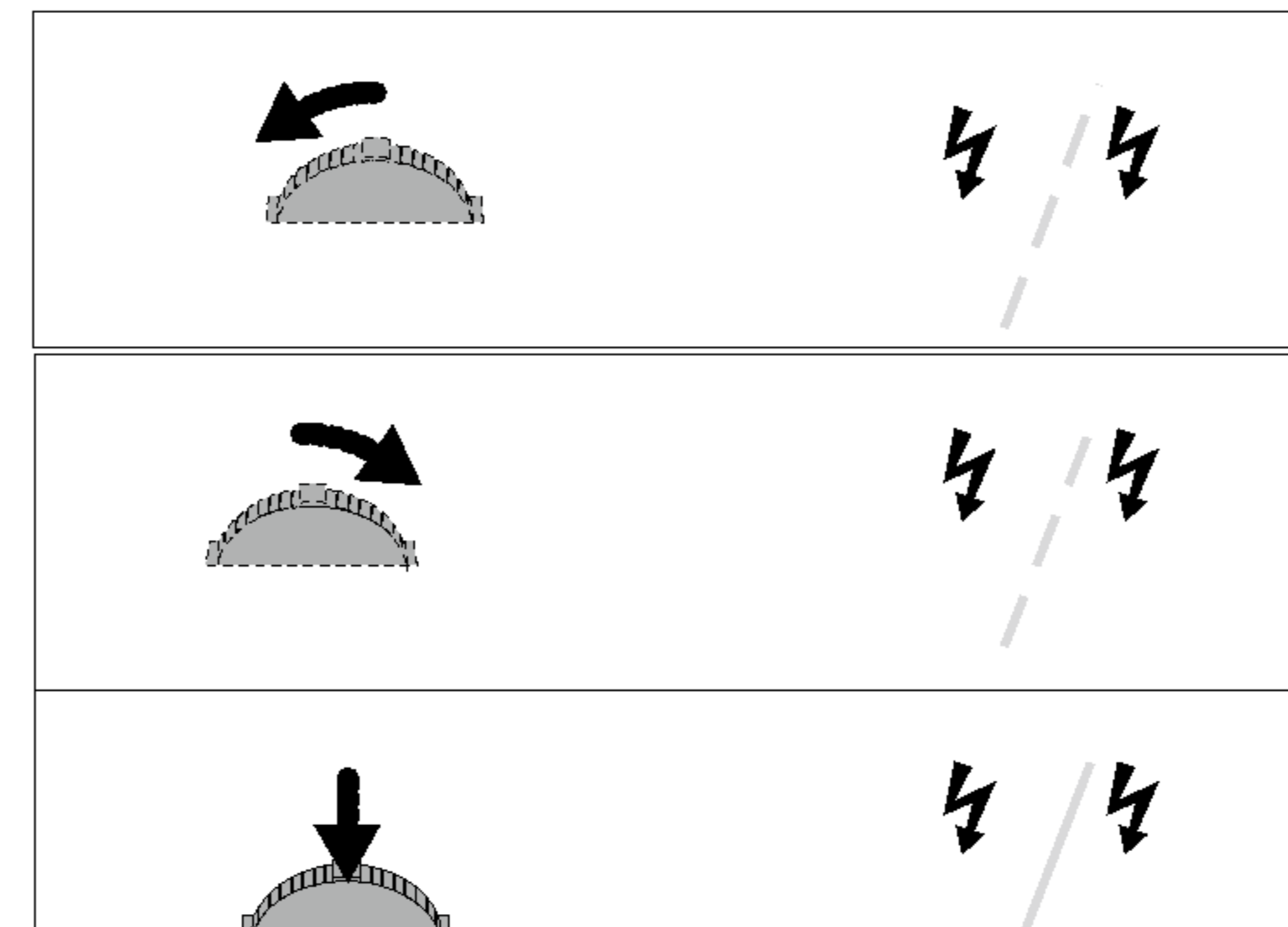
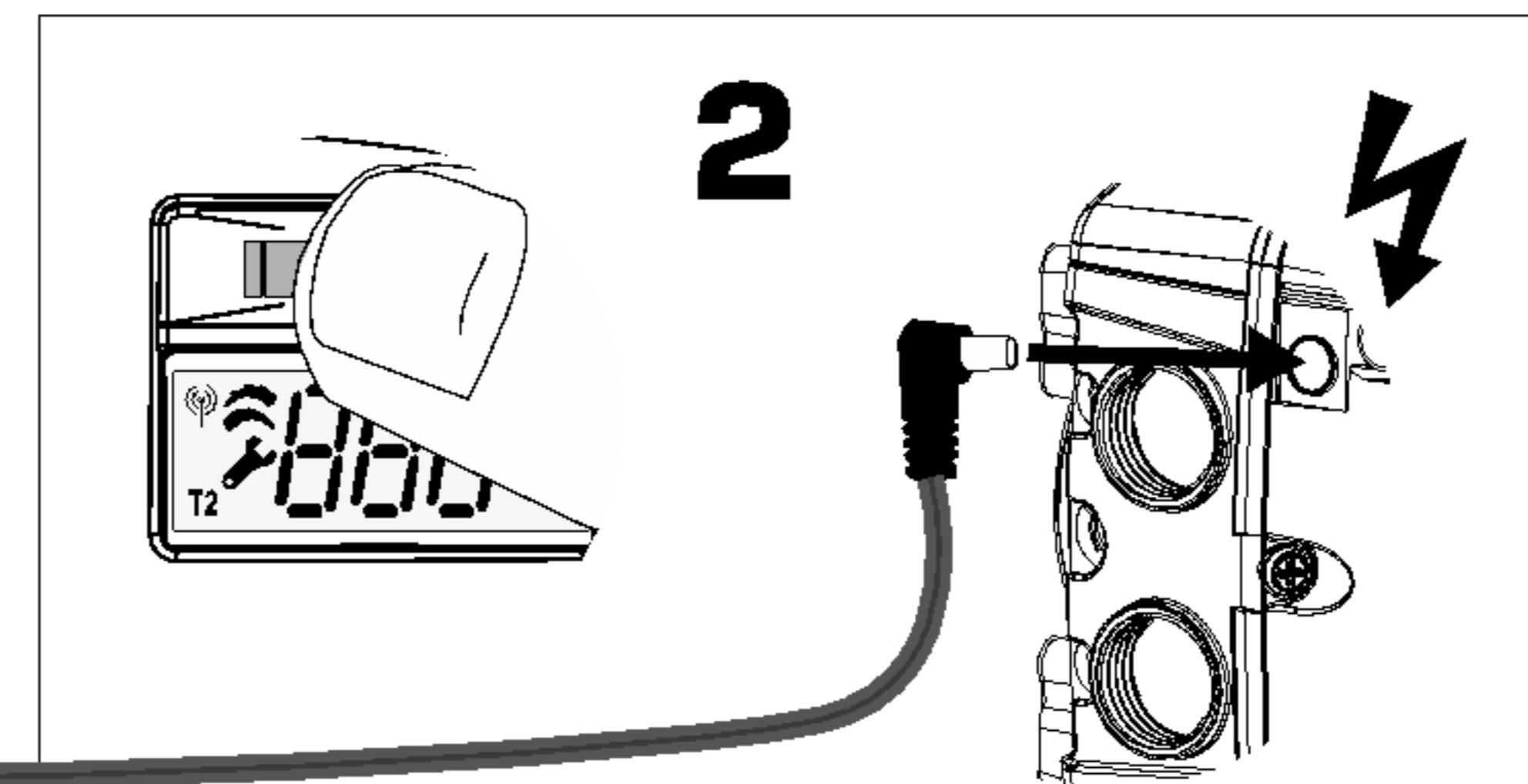
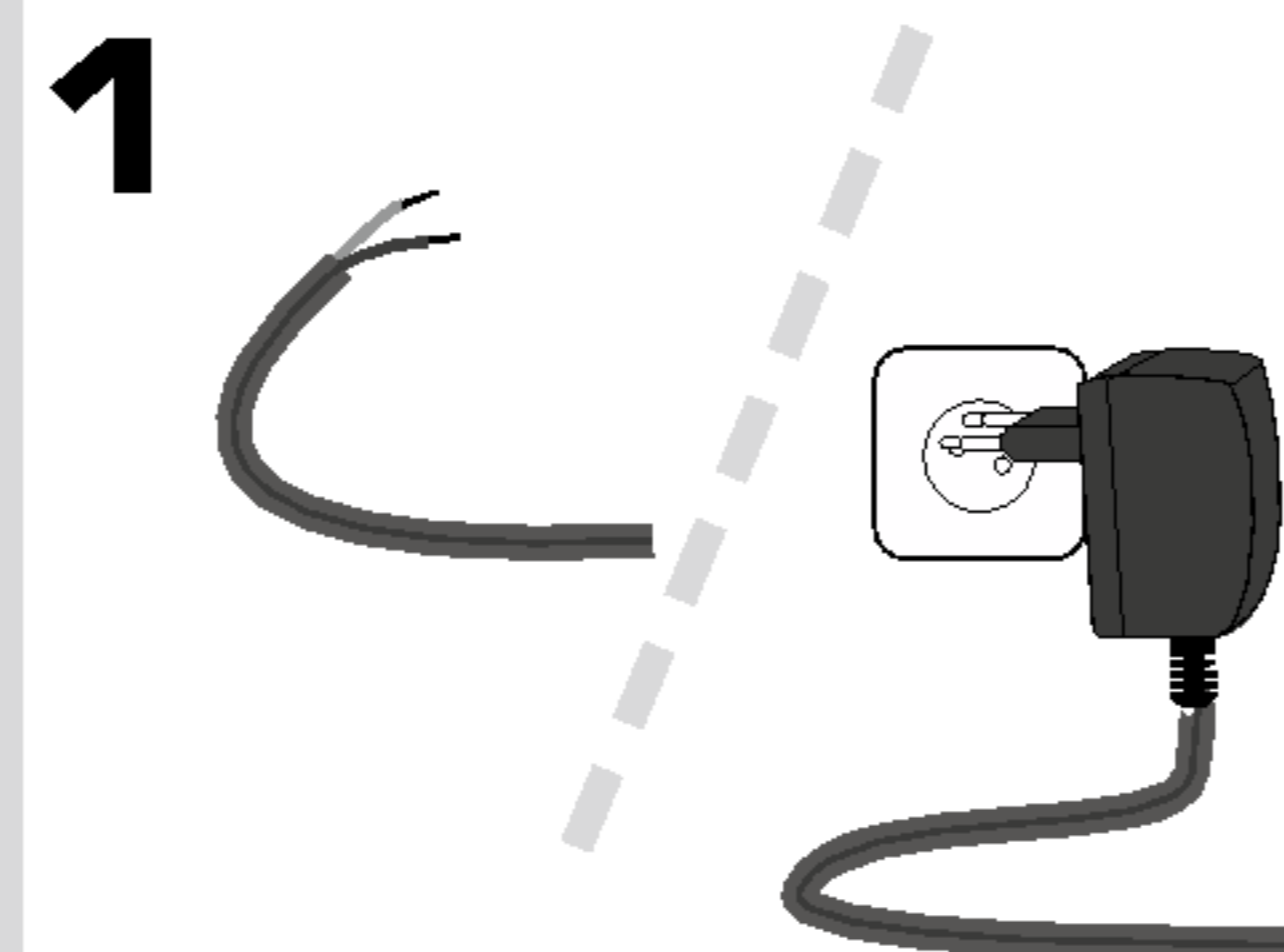
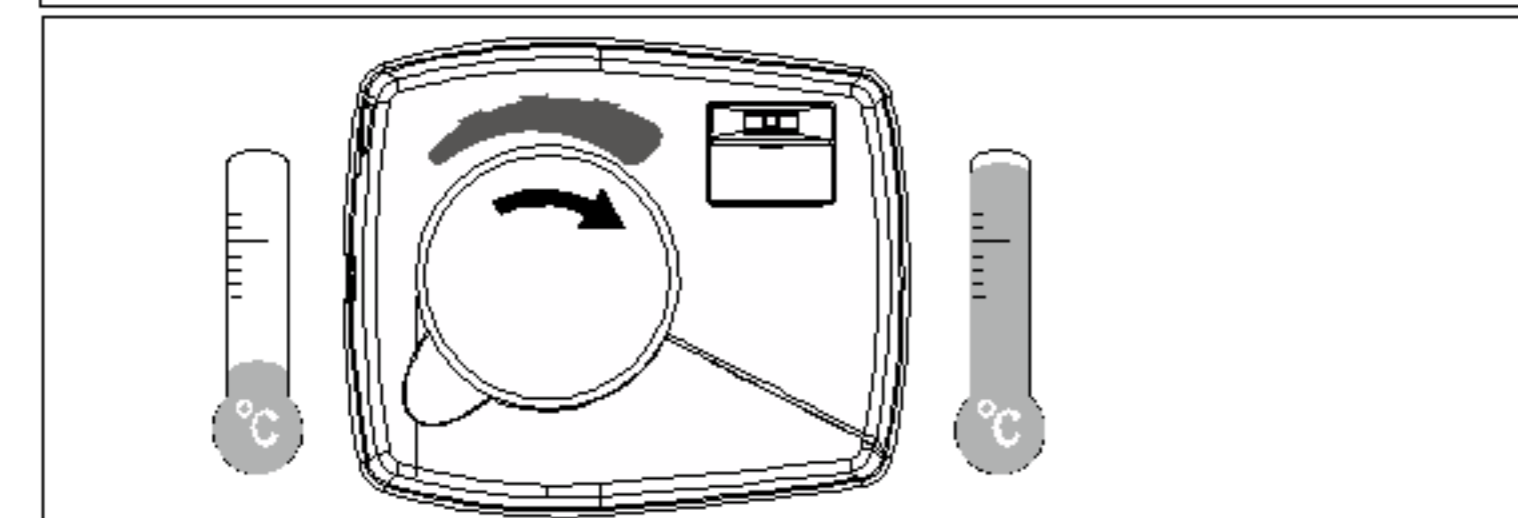
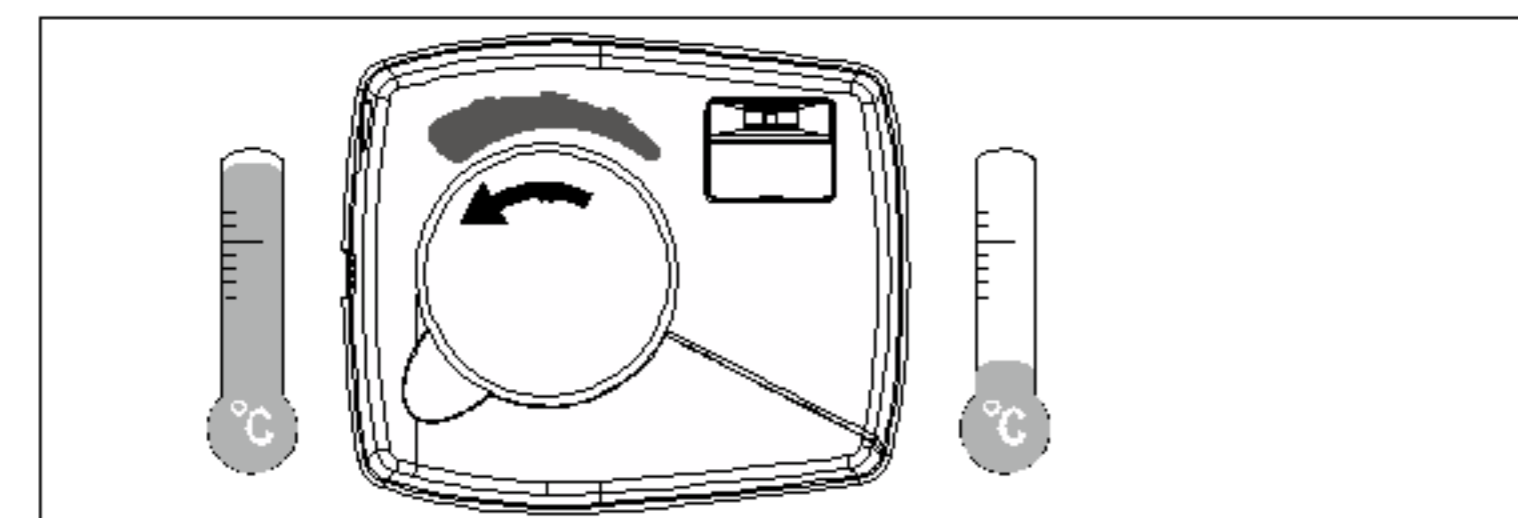
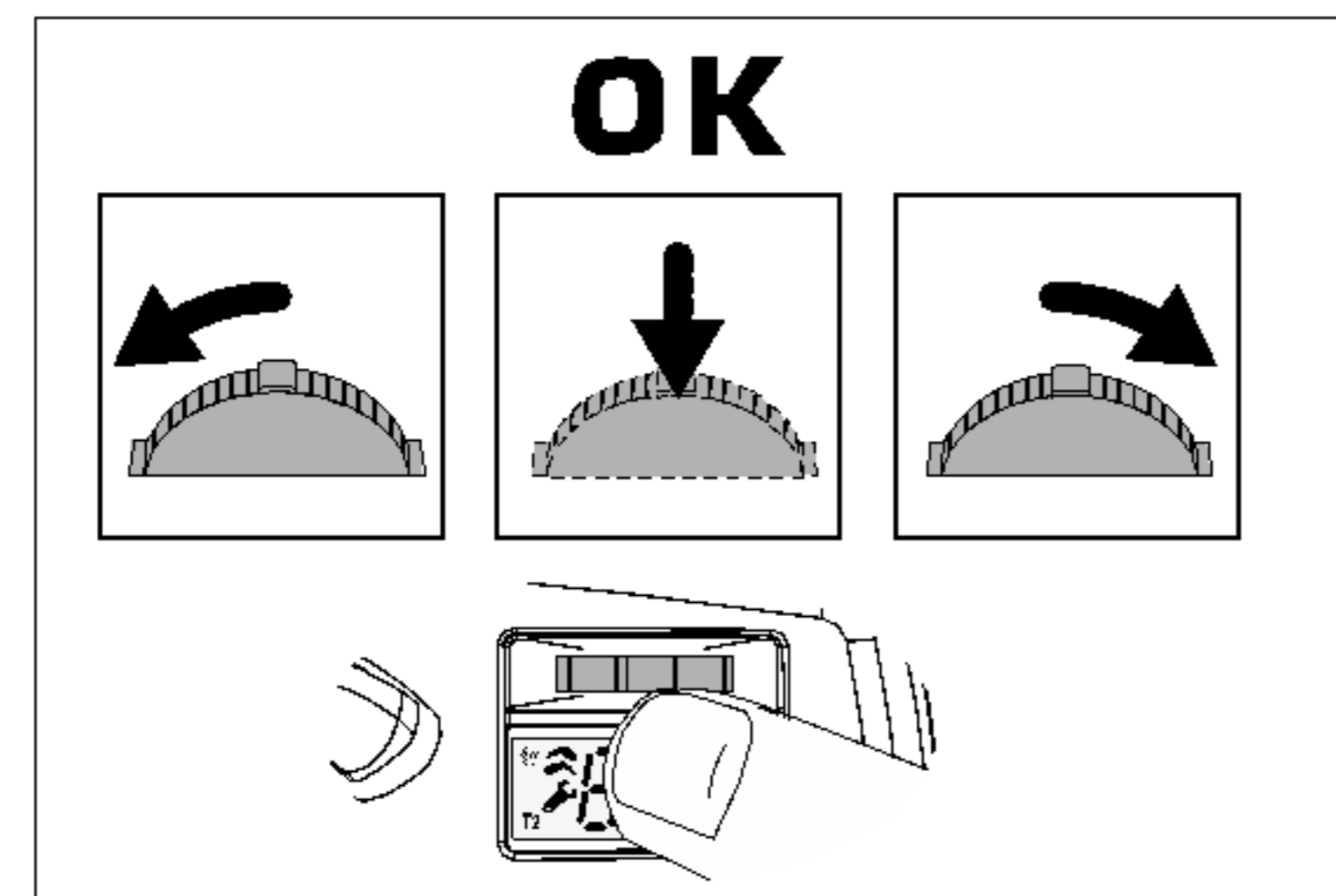

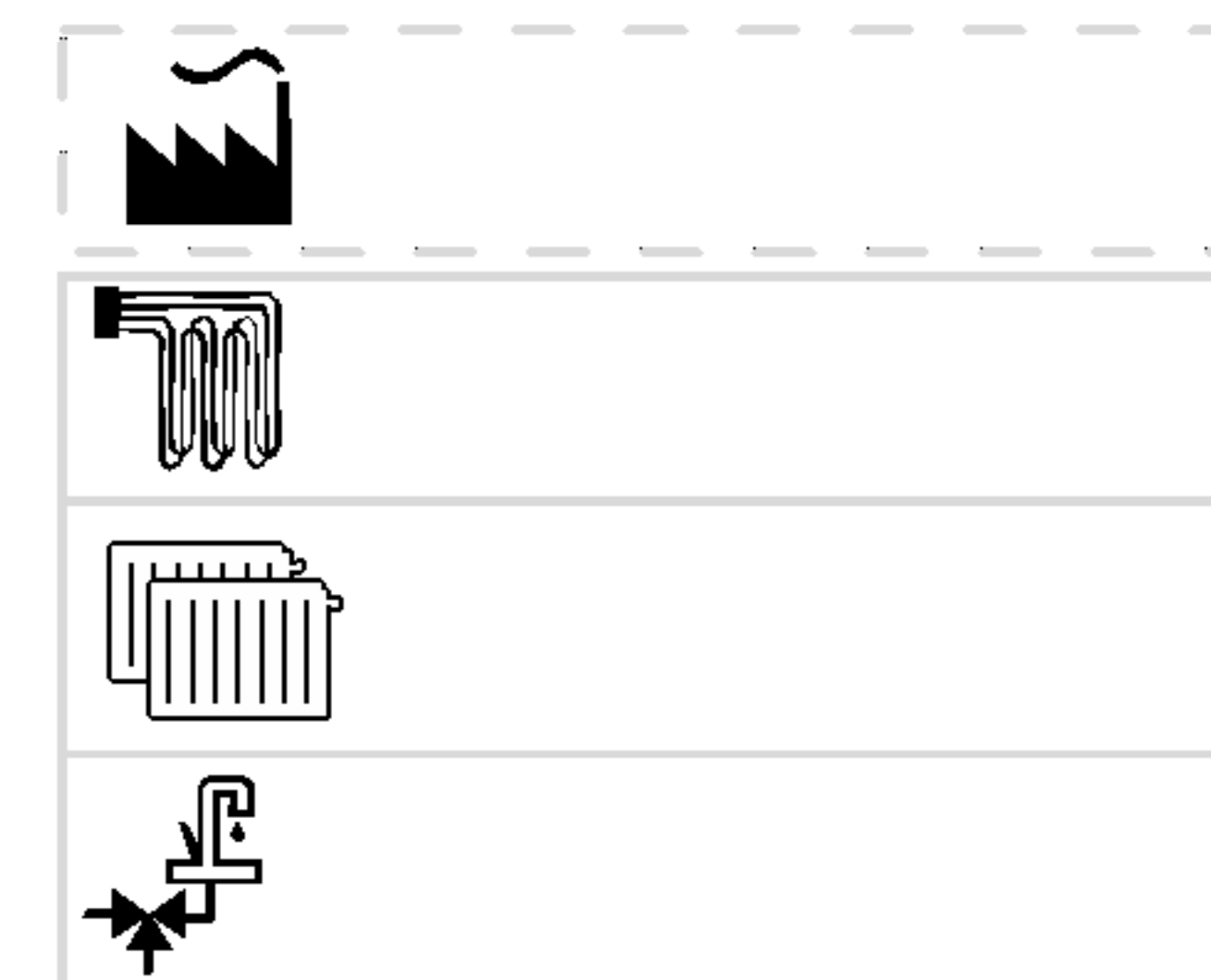
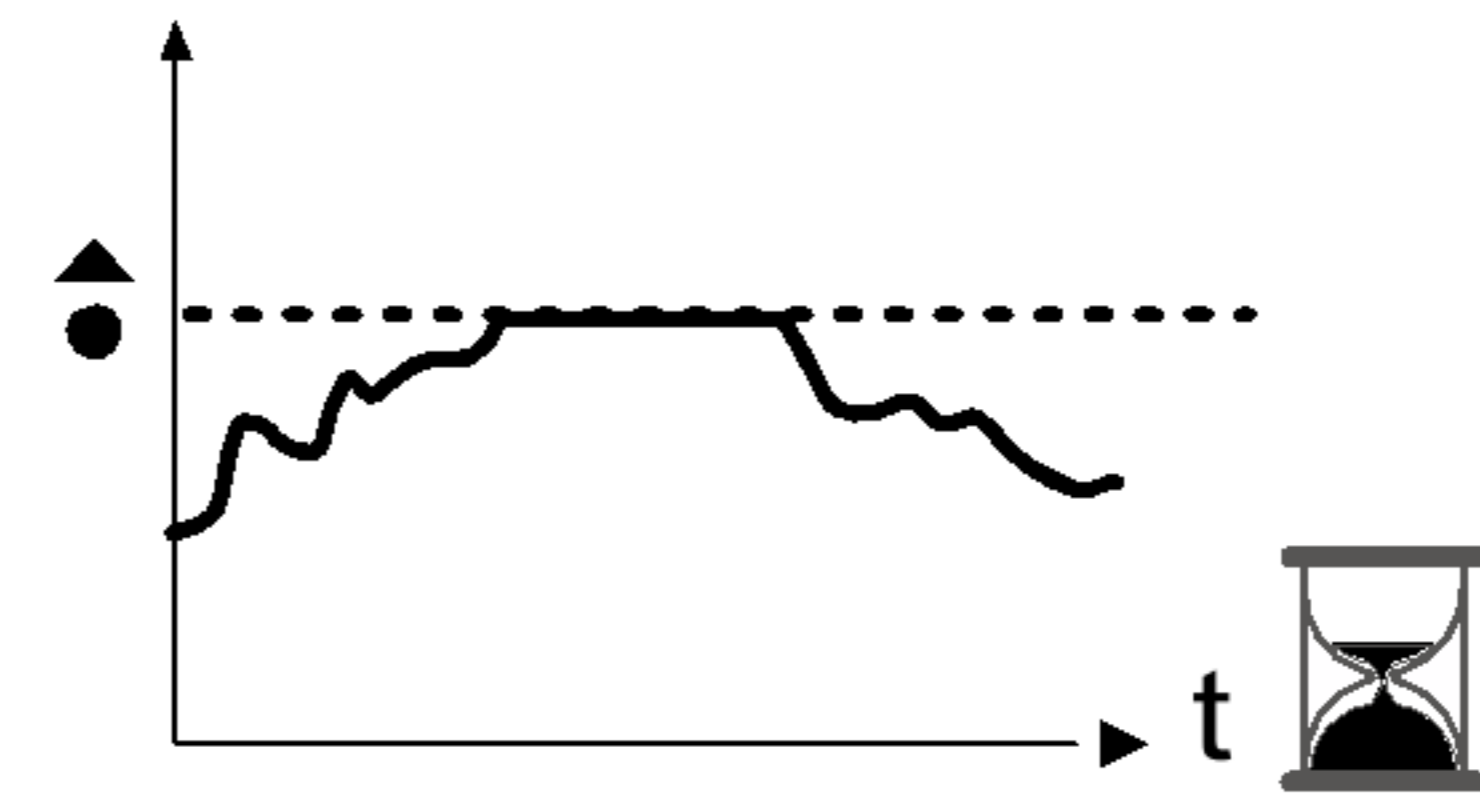
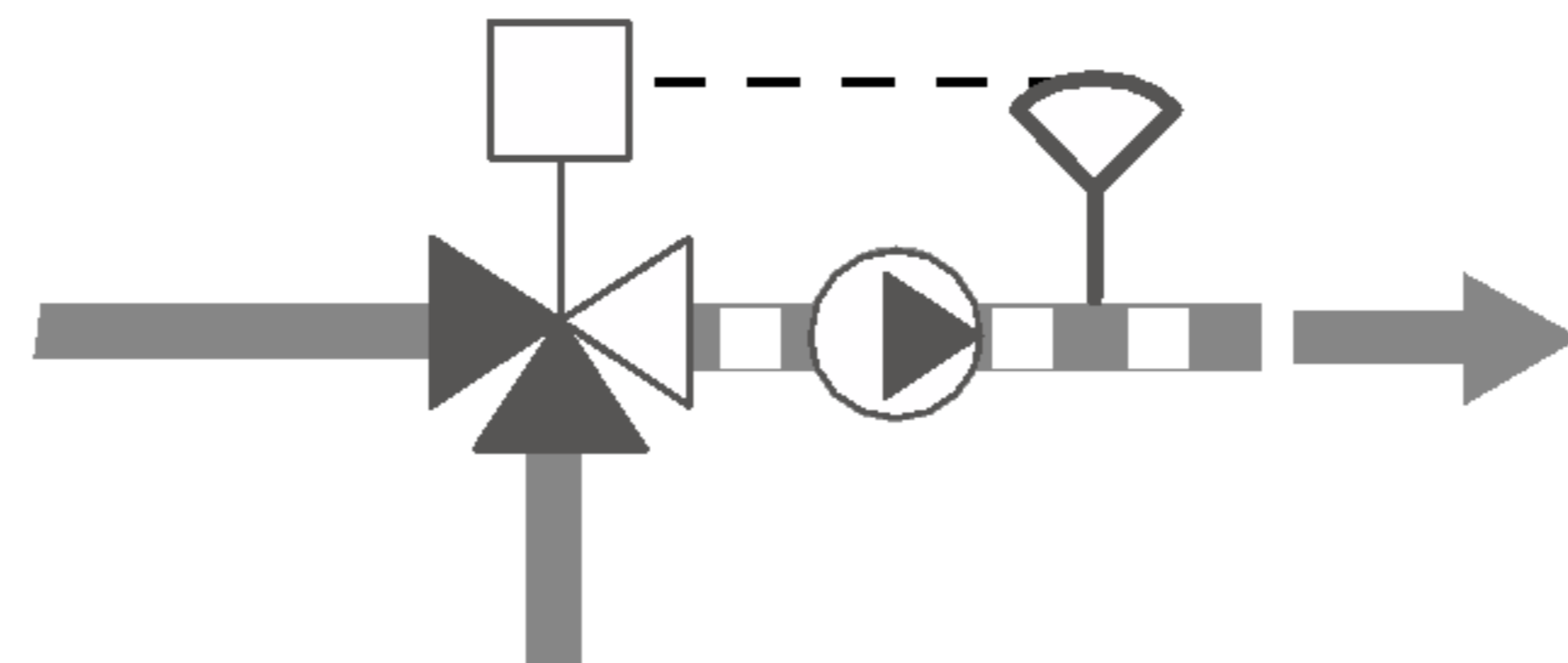
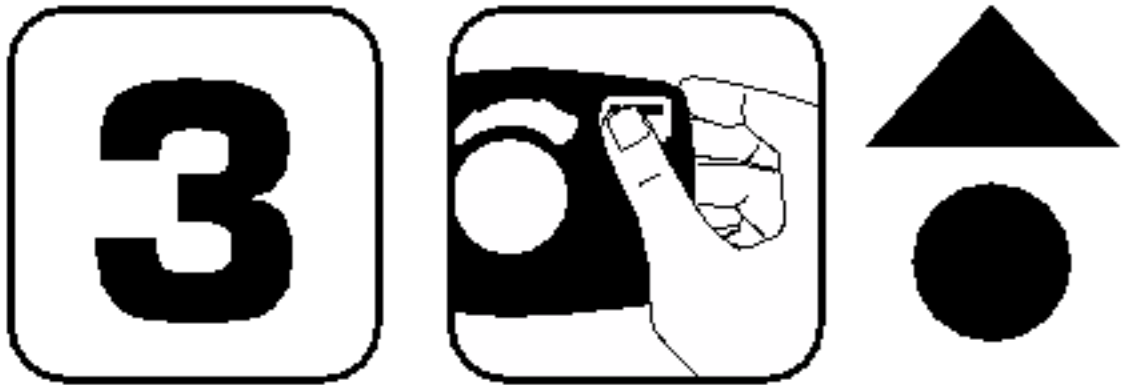

© KOMFORT

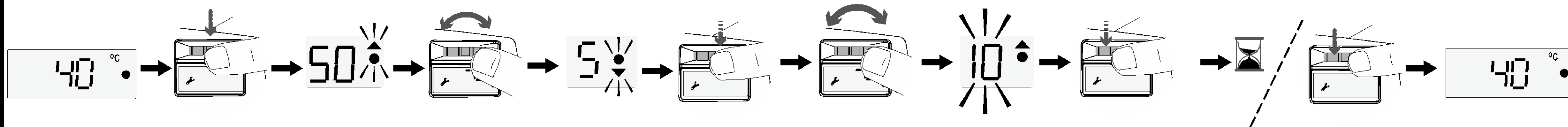
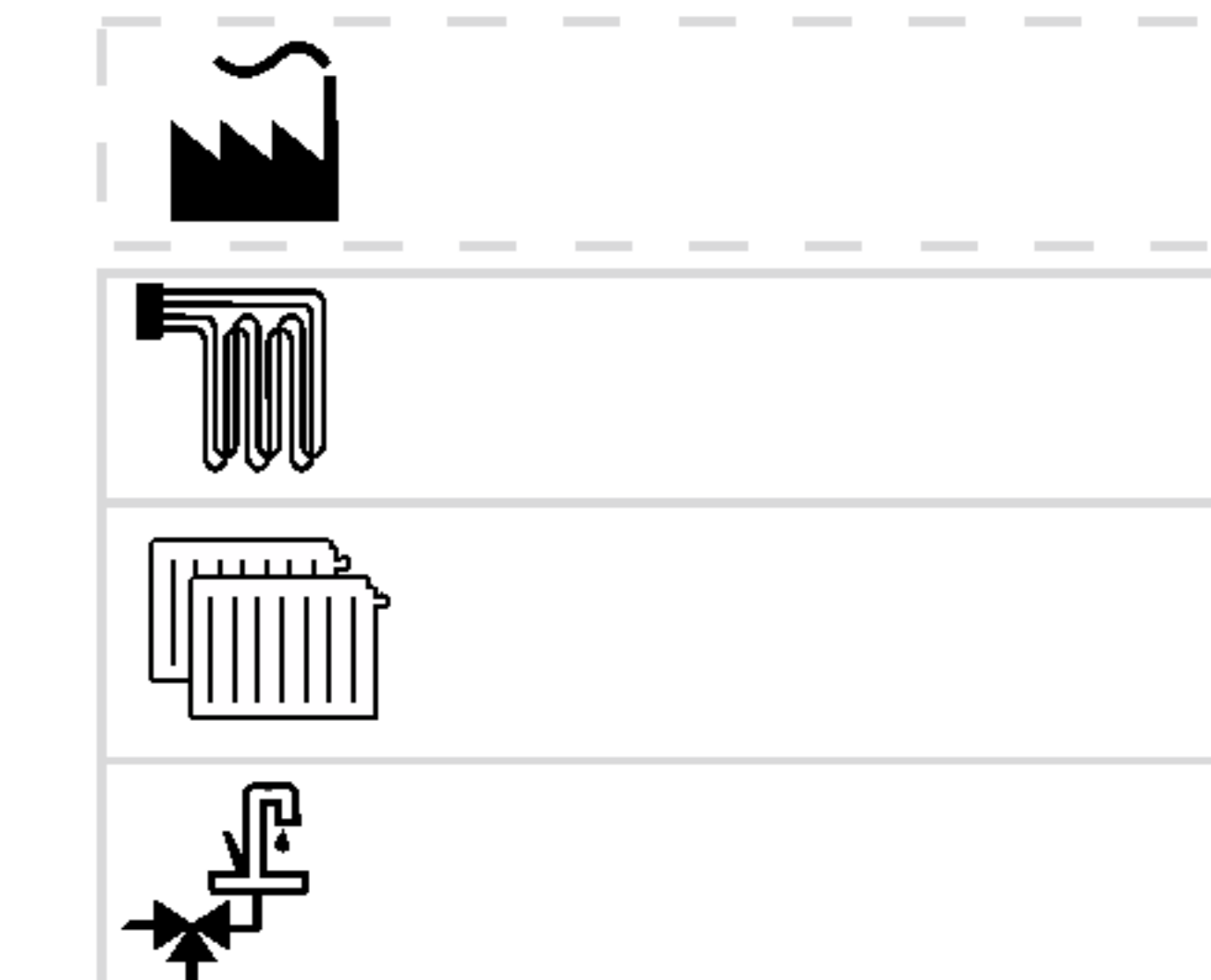
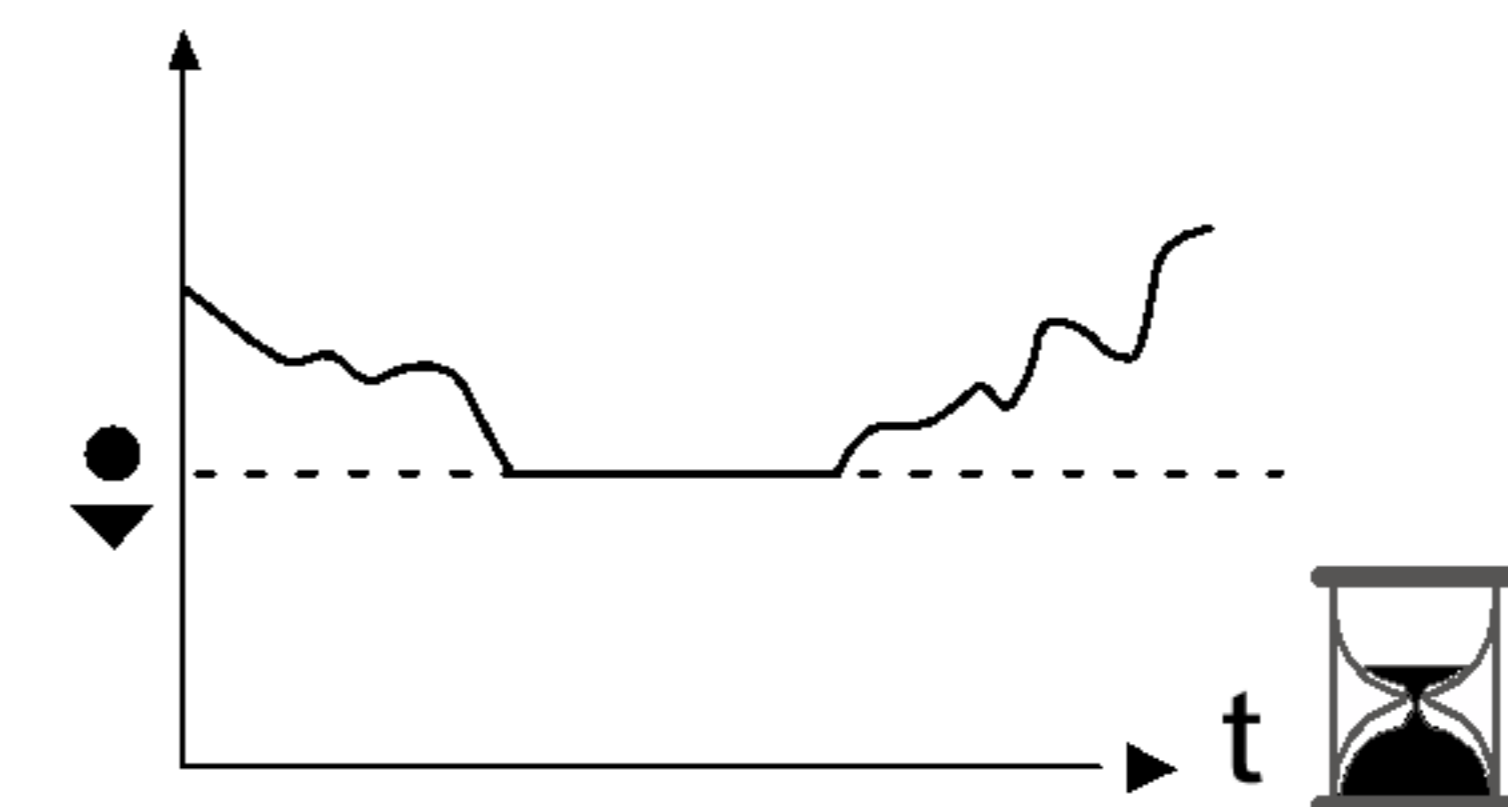
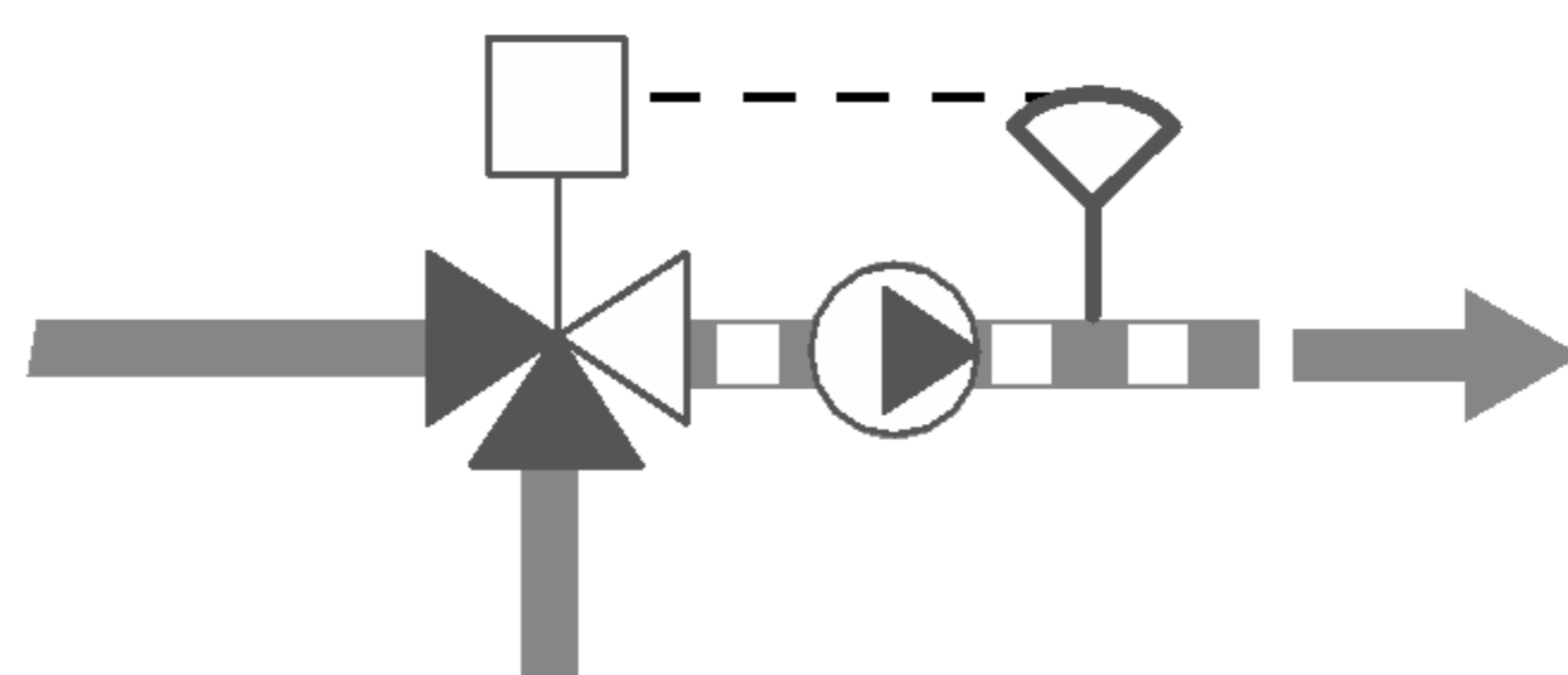
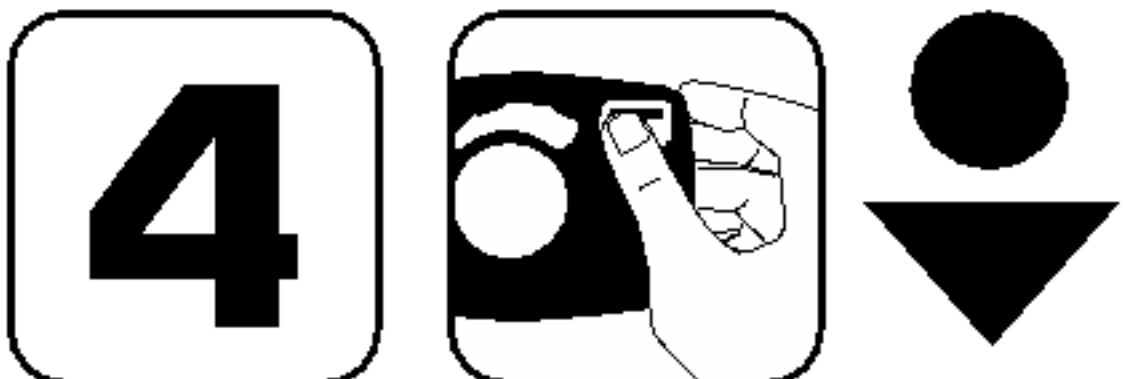
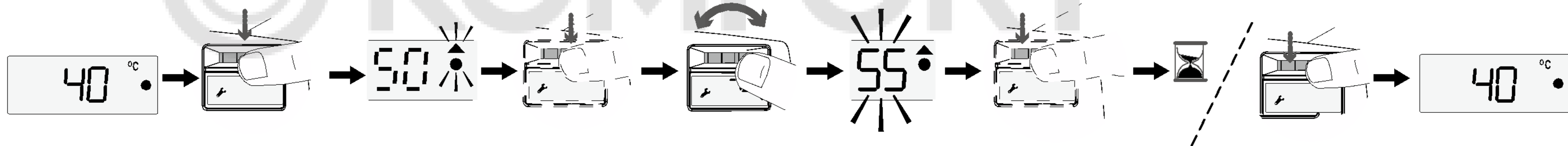

**5**  **T**



**i**

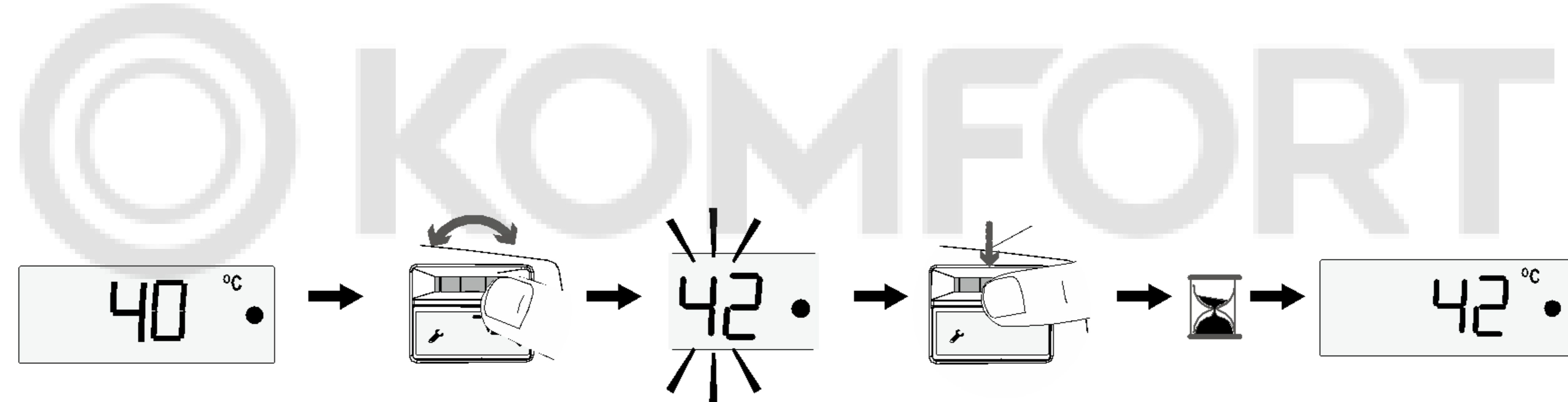
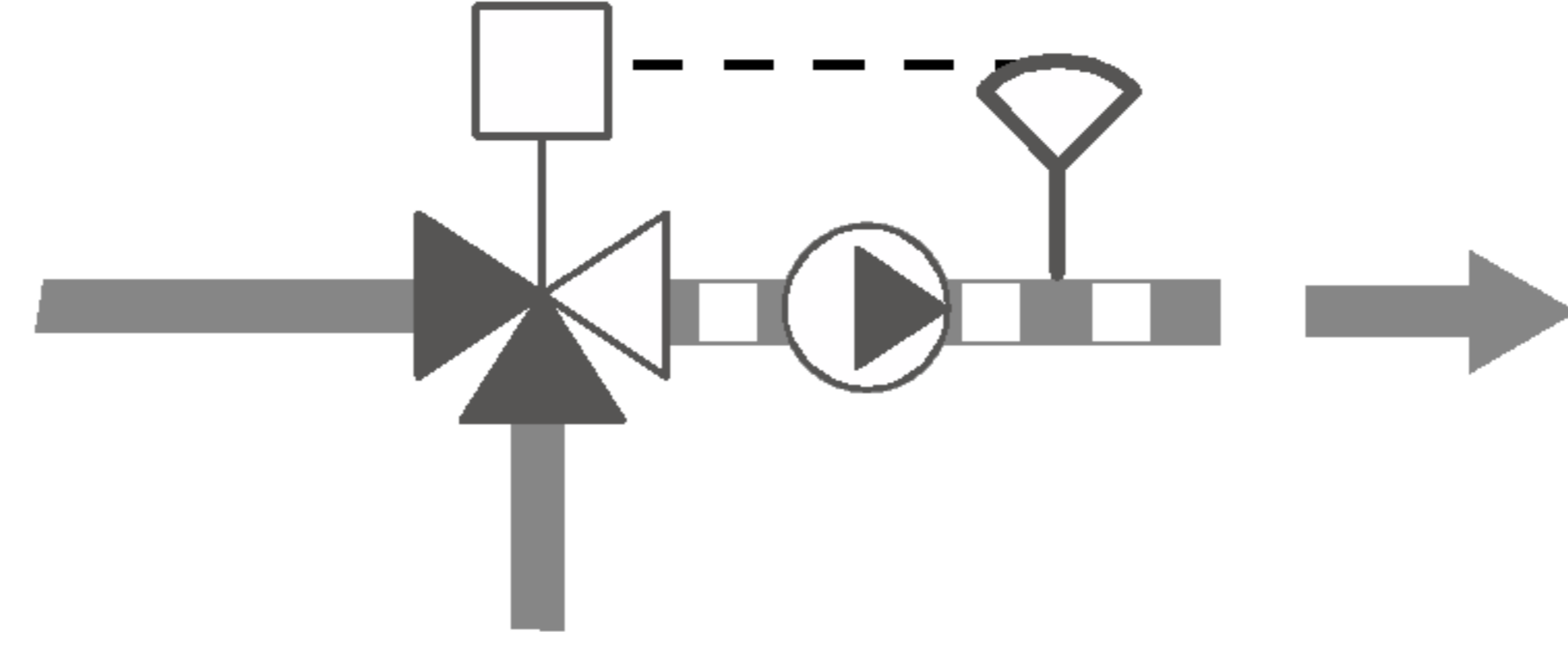
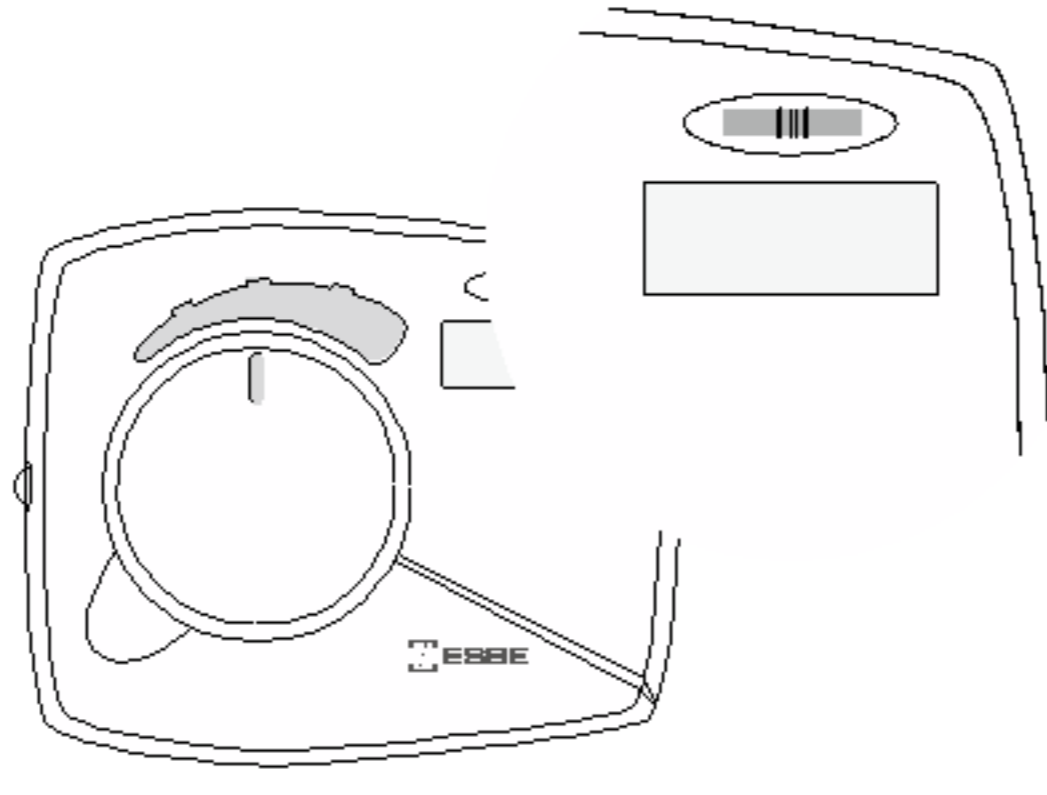

© KOMFORT

**6**  **T2**



**i**

