



Oras Electra

INSTALLATION AND MAINTENANCE GUIDE



© KOMFORT

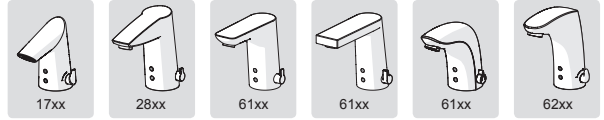

4-12



13-19



20



21-26



27



Oras App



apps.oras.com

Apple and the Apple logo are trademarks of Apple Inc., registered in the U.S. and other countries. App Store is a service mark of Apple Inc., registered in the U.S. and other countries.

Google Play and the Google Play logo are trademarks of Google Inc.

The Bluetooth® word mark and logos are registered trademarks owned by the Bluetooth SIG, Inc. and any use of such marks by Oras Group is under license. Other trademarks and trade names are those of their respective owners.



Lithium 2CR5 6 V
 I (ISO 3822)
 EN 15091
 EB (EN1717)

100 - 1000 kPa
 max. +70°C
 IP 55
CE (EMC 89/336/EEC)

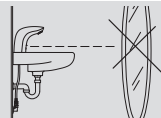
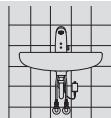

6150FZ
6150F
6150F/FZ-080
6150F/FZ-102
6150F/FZ-104
6150F/FZ-105
6150FP
6150FN
6150G

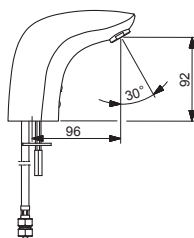
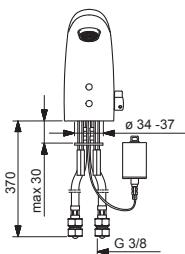

static.ors.com/6150FZ

6151FZ
6151F

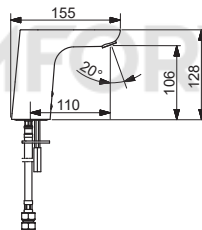
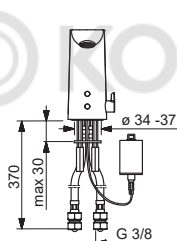

static.ors.com/6151FZ

6152FZ 100 - 500 kPa
6152F

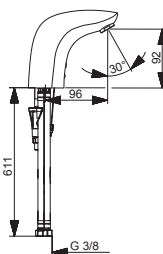
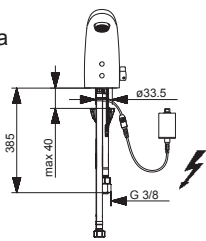

static.ors.com/6152FZ

6153FZ
6153F

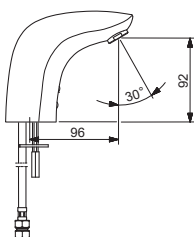
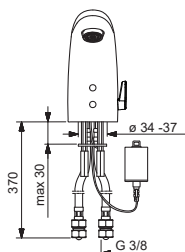

static.ors.com/6153FZ

Lithium 2CR5 6 V
 I (ISO 3822)
 EN 15091
 EB (EN1717)

100 - 1000 kPa
 max. +70°C
 IP 55
CE (EMC 89/336/EEC)

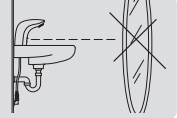
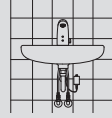

6155FZ ❄️
6155F

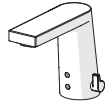
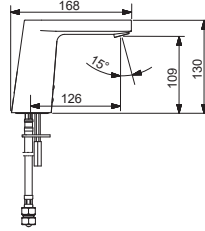
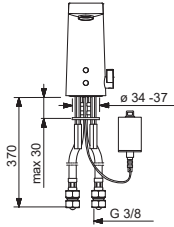

static.oras.com/6155FZ

6159FZ ❄️
6159F
6159FN
6159FP

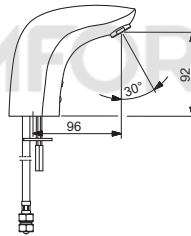
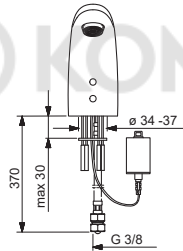

static.oras.com/6159FZ

6250FZ ❄️
6250F
6250F-E
6250FL-K
6250G
6250FP
6250FN

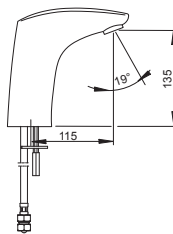
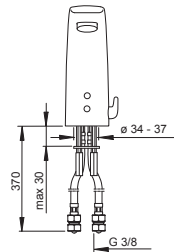

static.oras.com/6250FZ

1714FZ ❄️
1714F
1714F/FZ-102
1714FN
1714FP
1714F-L

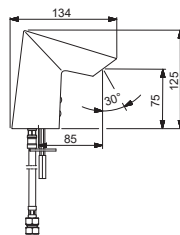
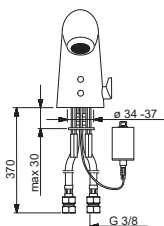

static.oras.com/1714FZ



Lithium 2CR5 6 V
 I (ISO 3822)
 EN 15091
 EB (EN1717)

100 - 1000 kPa
 max. +70°C
 IP 55
CE (EMC 89/336/EEC)

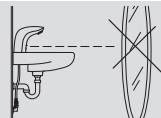
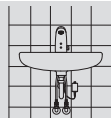

2814FZ
2814F

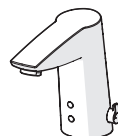
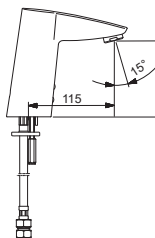
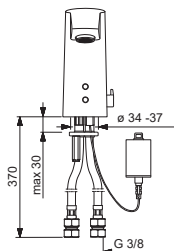

static.oras.com/2814FZ

2816FZ
2816F

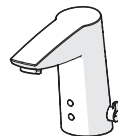
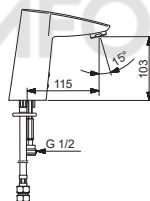
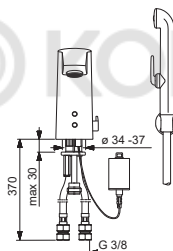

static.oras.com/2816FZ

12 VDC
I (ISO 3822)
EN 15091
EB (EN1717)

100 - 1000 kPa
max. +70°C
IP 55
CE (EMC 89/336/EEC)

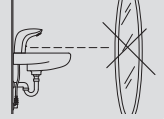
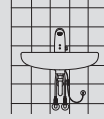

6120FZ ❄️
6120F
6120F-E
6120G
6120F/FZ-080
6120F/FZ-102
6120F/FZ-104
6120F-105
6120FP/FN

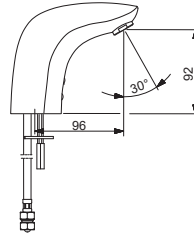
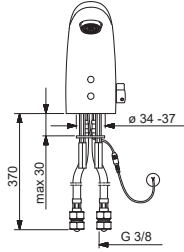

static.oras.com/6120FZ

6120FTZ ❄️
6120FT
6120FNT
6120FPT

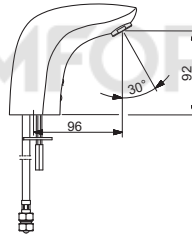
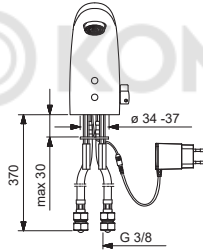

static.oras.com/6120FTZ

6121FZ ❄️
6121F

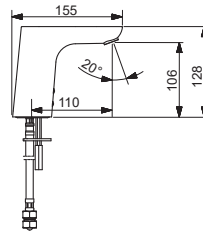
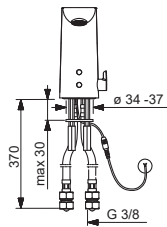

static.oras.com/6121FZ

6123FZ ❄️
6123F

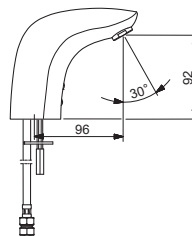
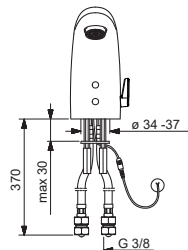

static.oras.com/6123FZ



12 VDC
I (ISO 3822)
EN 15091
EB (EN1717)

100 - 1000 kPa
max. +70°C
IP 55
CE (EMC 89/336/EEC)

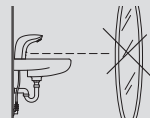
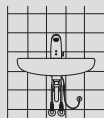

6123FTZ
6123FT

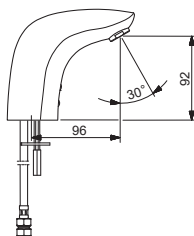
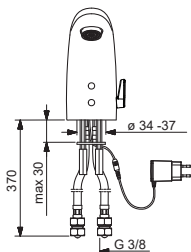

static.oras.com/6123FTZ

6125FZ
6125F

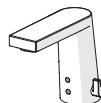
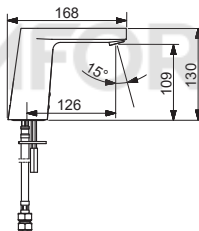
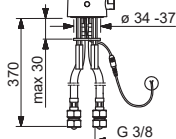

static.oras.com/6125FZ

6221FZ 100 - 500 kPa
9 VDC

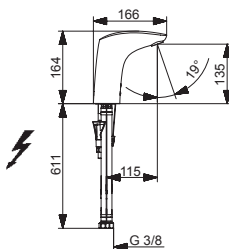
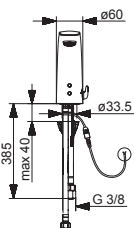

static.oras.com/6221FZ

6222FZ 9 VDC
6222F

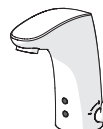
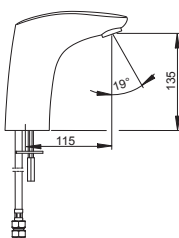
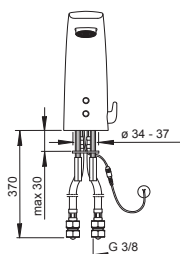

static.oras.com/6222FZ

12 VDC
I (ISO 3822)
EN 15091
EB (EN1717)

100 - 1000 kPa
max. +70°C
IP 55
CE (EMC 89/336/EEC)

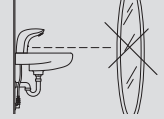
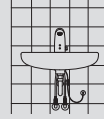

6222FLZ 100 - 500 kPa
9 VDC

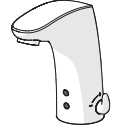
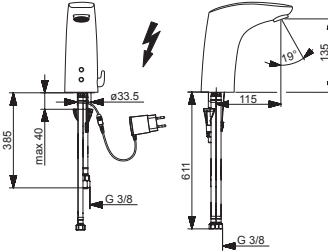

static.oras.com/6222FLZ

6223FLZ 100 - 500 kPa
9 VDC

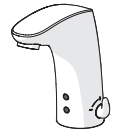
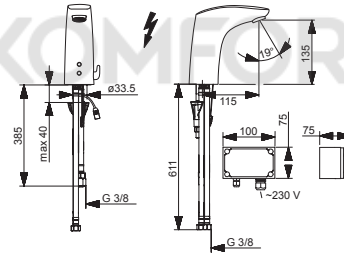

static.oras.com/6223FLZ

6223FTZ 9 VDC
6223FT

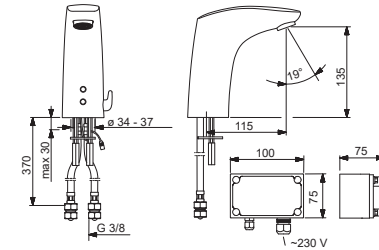

static.oras.com/6223FTZ

1724FTZ 9 VDC
1724FT

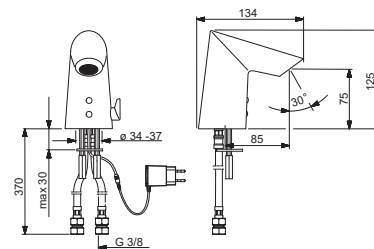

static.oras.com/1724FTZ



12 VDC
I (ISO 3822)
EN 15091
EB (EN1717)

100 - 1000 kPa
max. +70°C
IP 55
CE (EMC 89/336/EEC)

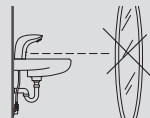
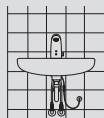

2824FTZ 9 VDC
2824FT
2824FNT

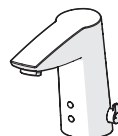
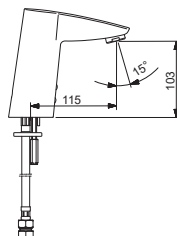
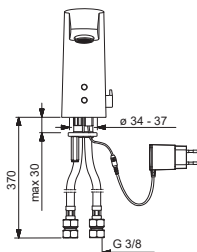

static.ors.com/2824FTZ

2824F-102
2824F-104
2824F-105

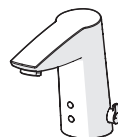
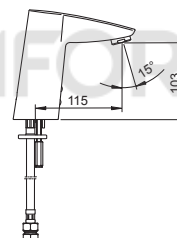
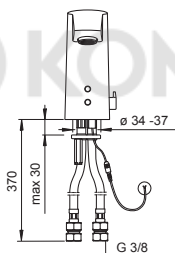

static.ors.com/2824F-102

2826FZ 9 VDC
2826F

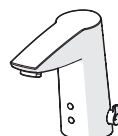
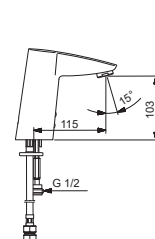
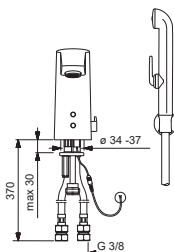

static.ors.com/2826FZ

2826FTZ 9 VDC
2826FT

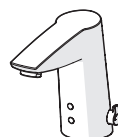
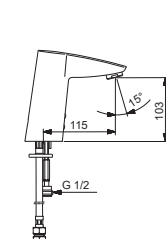
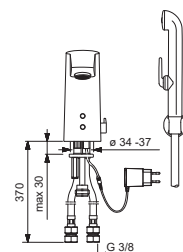

static.ors.com/2826FTZ

12 VDC
I (ISO 3822)
EN 15091
EB (EN1717)

100 - 1000 kPa
max. +70°C
IP 55
CE (EMC 89/336/EEC)

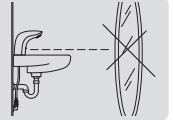
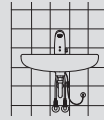

2827FZ 9 VDC
2827F

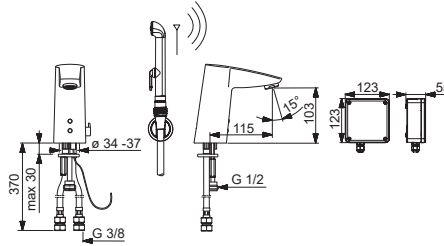

static.oras.com/2827FZ

- GB** Power supply requirement: Power supply output must be short circuit protected
- CZ** Požadavky týkající se napájecího zdroje: Výstup napájecího zdroje musí být chráněn proti zkratu
- DE** Stromversorgungsvoraussetzungen: Stromversorgungsspannung muss kurzschlussgeschützt sein.
- DK** Krav til strømforsyning: Strømforsyningsudgang skal være kortslutningsbeskyttet
- EE** Nõuded vooluallikale: Vooluallika väljund peab olema kaitstud lühise eest
- ES** Requisitos del suministro eléctrico: el suministro eléctrico debe estar protegido contra cortocircuitos
- FI** Vaatimukset virtalähteelle: Virtalähteen ulostulon tulee olla oikosulkusuojattu
- FR** Unité d'alimentation électrique: La sortie de l'unité d'alimentation doit être protégée contre le court-circuit
- IT** Requisiti dell'alimentazione: L'uscita deve essere protetta da cortocircuito
- LT** Reikalavimai maitinimo šaltiniui: turi būti apsauga nuo trumpo jungimo
- LV** Prasības attiecībā uz barošanas ierīci: ierīces izvadam jābūt aizsargātam pret īsslēgumiem
- NL** Vereisten voor de voeding: De uitgang van de voeding moet beschermd zijn tegen kortsluitingen
- NO** Krav til strømforsyning: Strømforsyningsspenning må være kortslutningssikret
- PL** Wymagania w stosunku do zasilacza: Zasilacz musi być wyposażony w zabezpieczenie przeciwzwarciowe
- RO** Pentru alimentarea cu putere: borna de putere trebuie să fie protejată la scurtcircuit
- RU** Требования к источнику тока: Выход источника тока защищен от короткого замыкания
- SE** Krav på matningsdon: Utspänningen skall vara kortslutningssäker
- SK** Požiadavka na napájanie: Výstup napájania musí byť chránený voči skratu.
- UA** Вимоги до джерела струму: Вихід джерела струму захищений від короткого замикання.
- PT** Requisitos de alimentação eléctrica: a alimentação eléctrica deve estar protegida contra curto-circuito.
- GR** Προϋποθέσεις για αδιάλειπτη παροχή ρεύματος: Τάση εξόδου ασφαλισμένη έναντι βραχυκυκλώματος
- SI** Zahteva za napajanje: Izhod za napajanje mora biti zaščiten s kratkim stikom
- HU** Áramellátás: A tápegység kimeneténél fontos az érintésvédelmet biztosítani.

© KOMFORT

Oras 199275

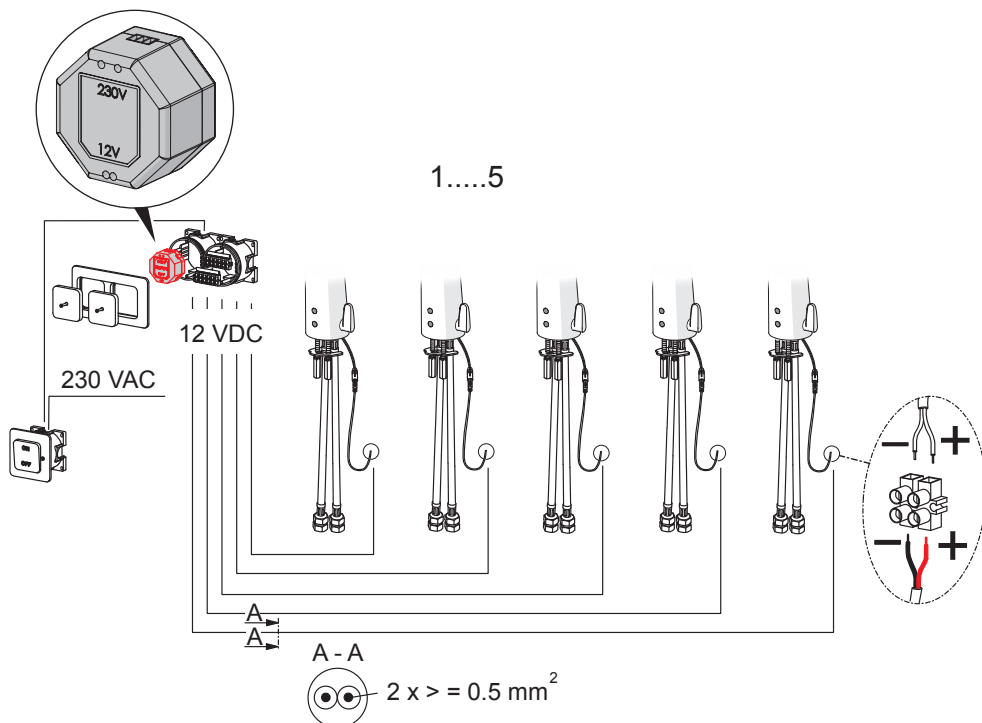

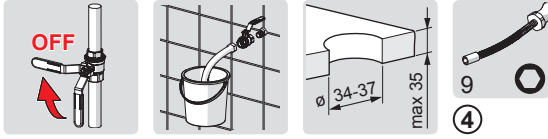

1
A

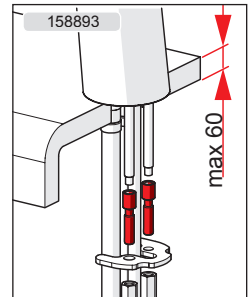
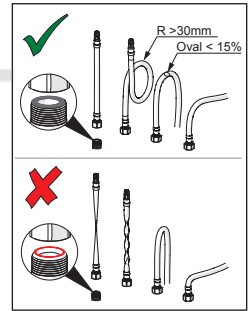
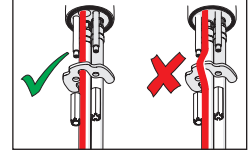
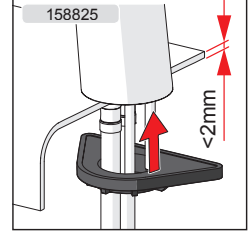
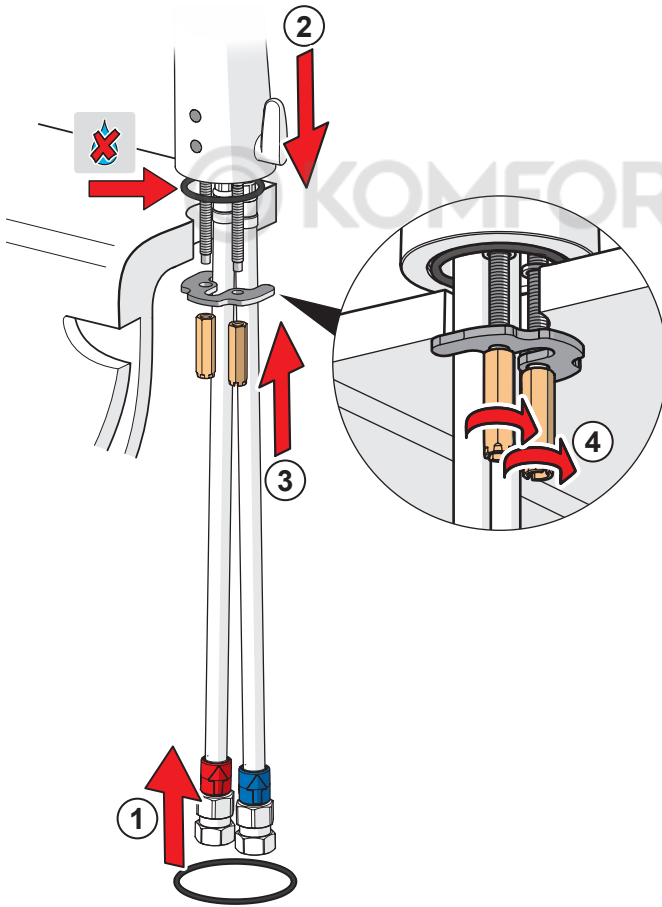

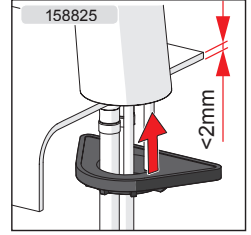
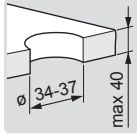
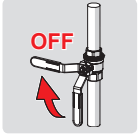

1

B

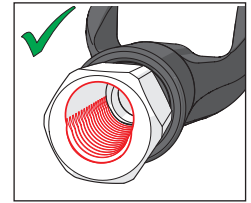
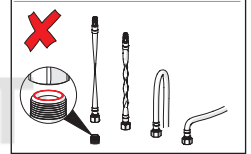
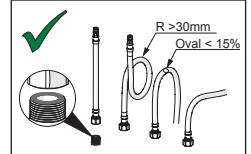
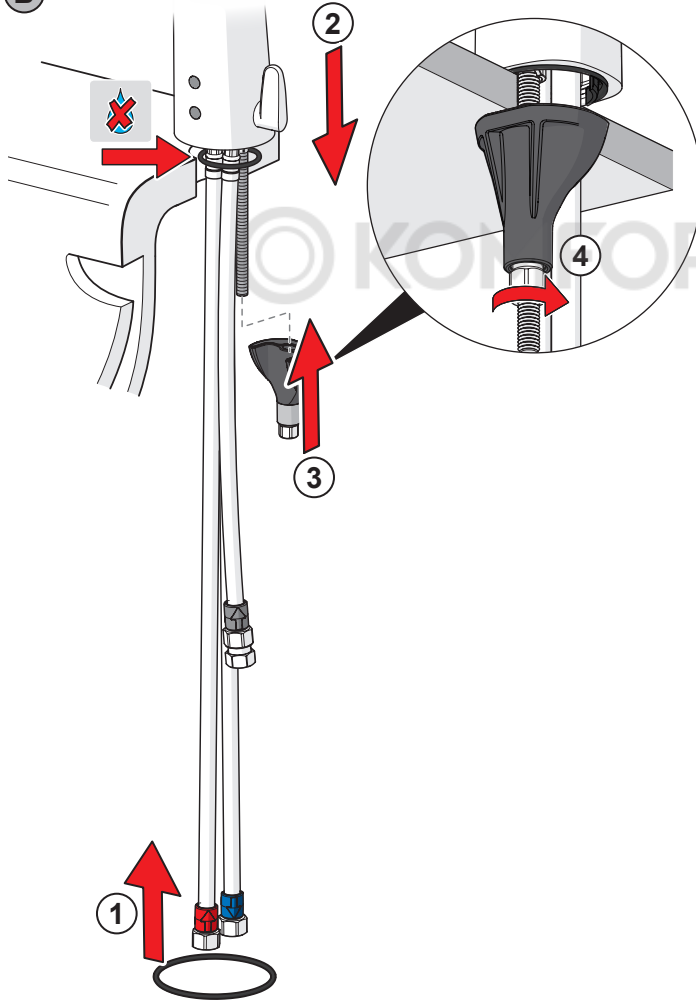

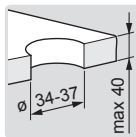
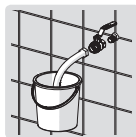
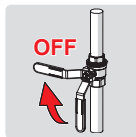

1

C

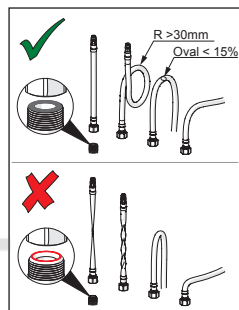
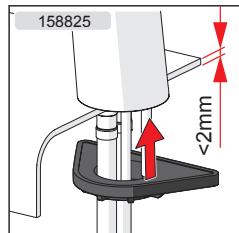
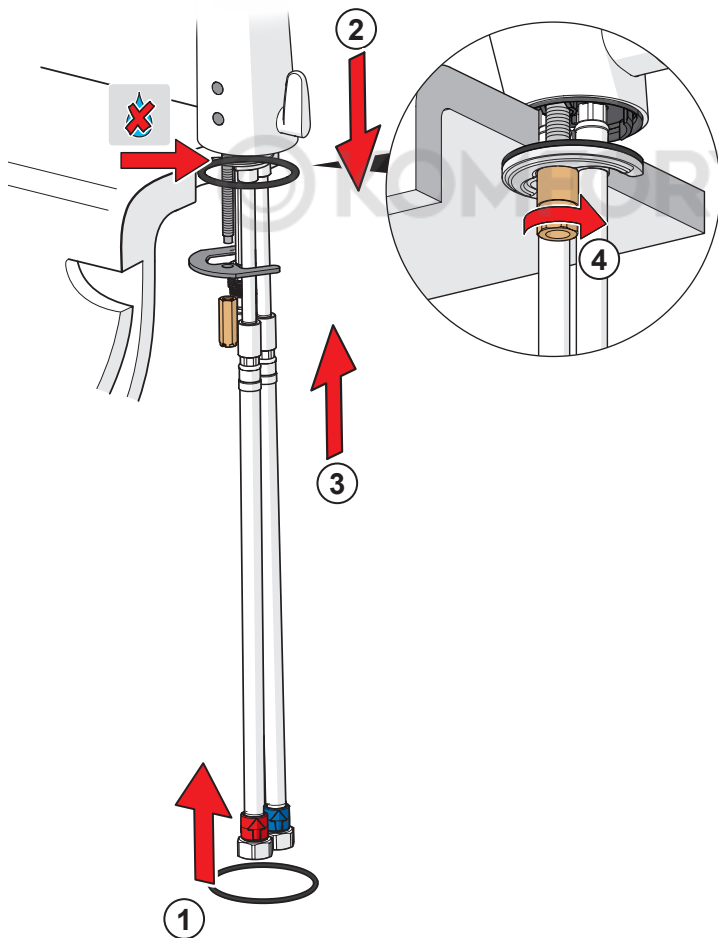



1 2

max.
1600 kPa

2

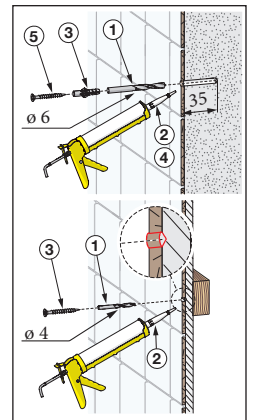
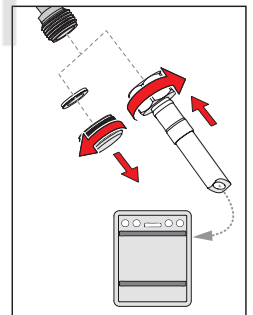
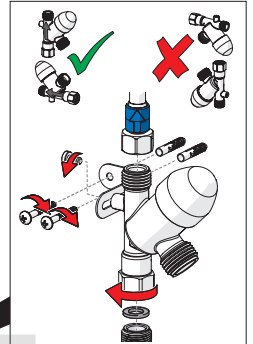
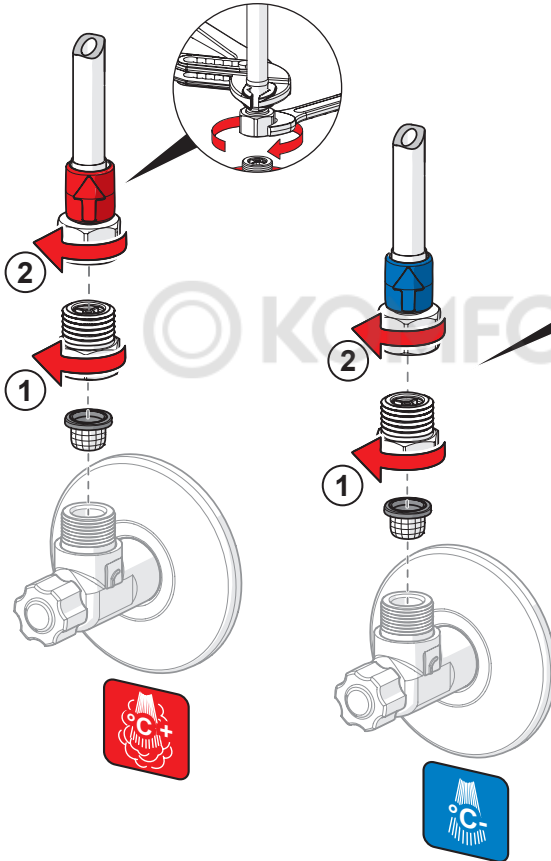

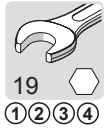

2

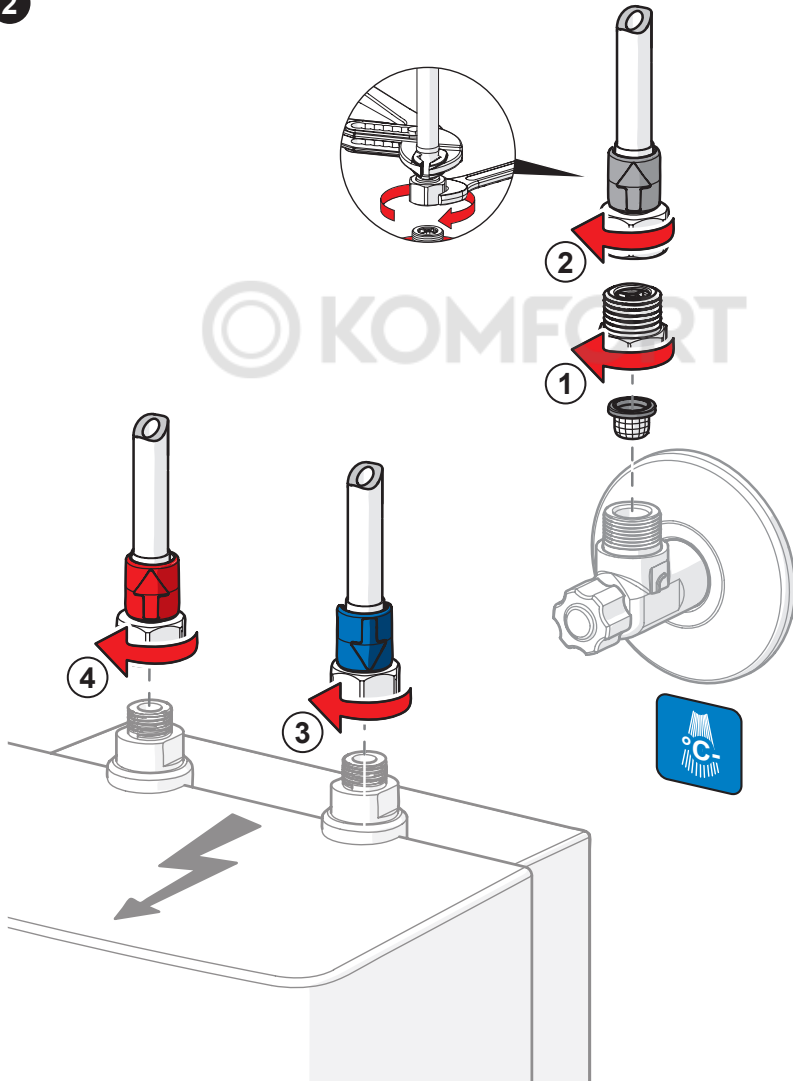



3 A

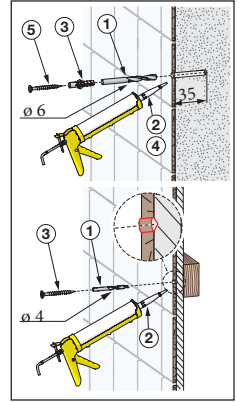
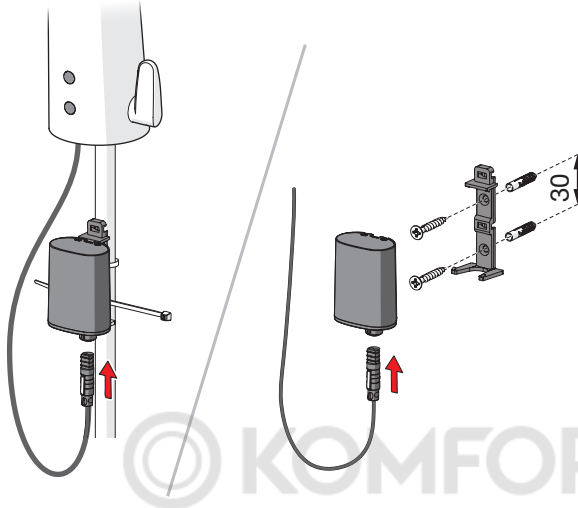

© KOMFORT

3 B

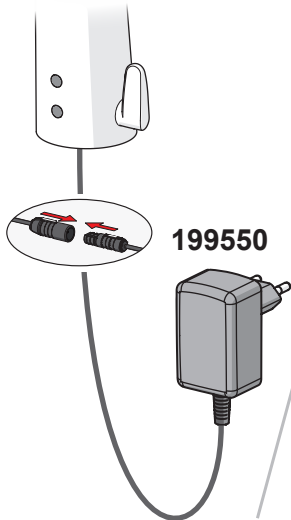

3 C

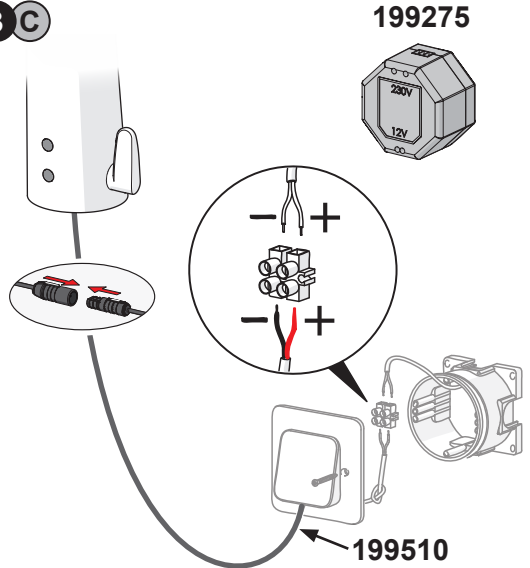

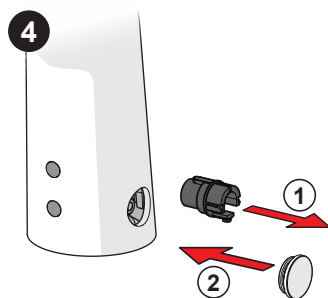
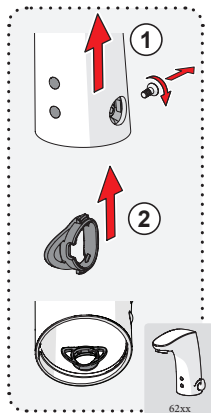
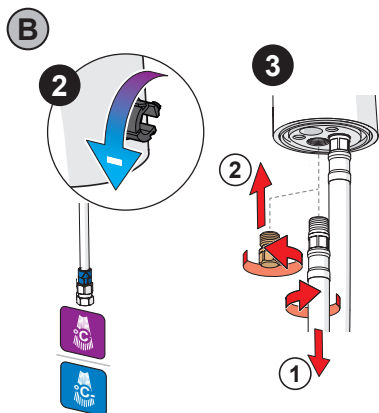
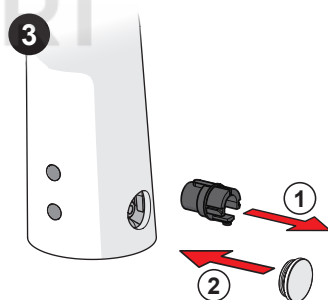
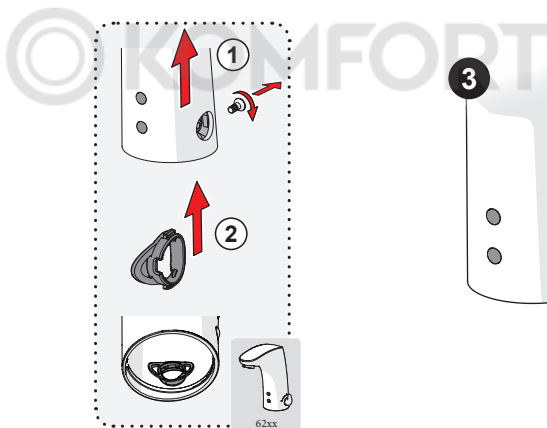
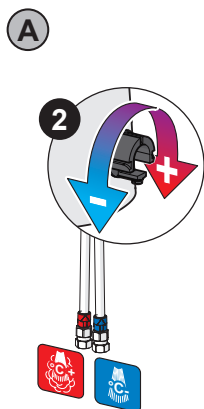
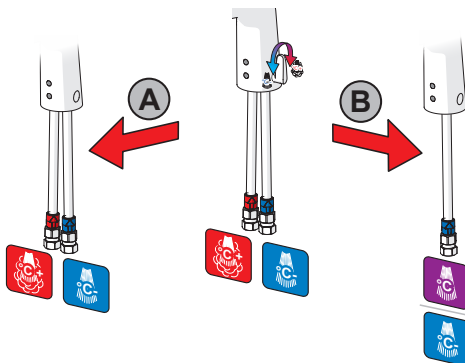
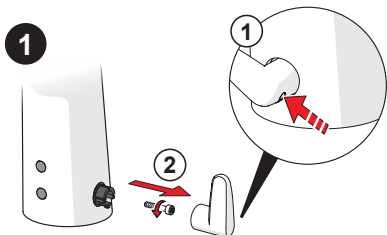
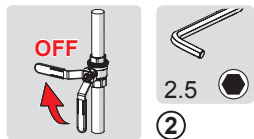



AUTOMATIC

2 s ± 1 s

max. 2 min

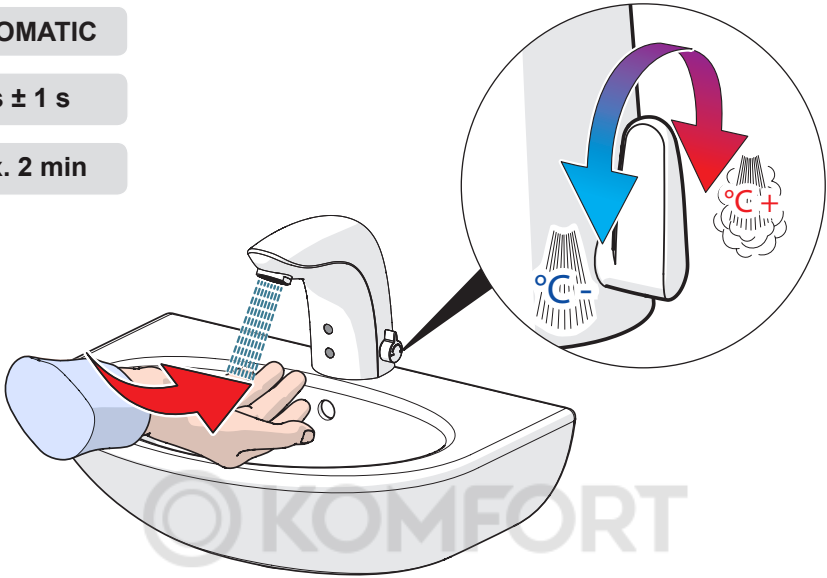

KOMFORT

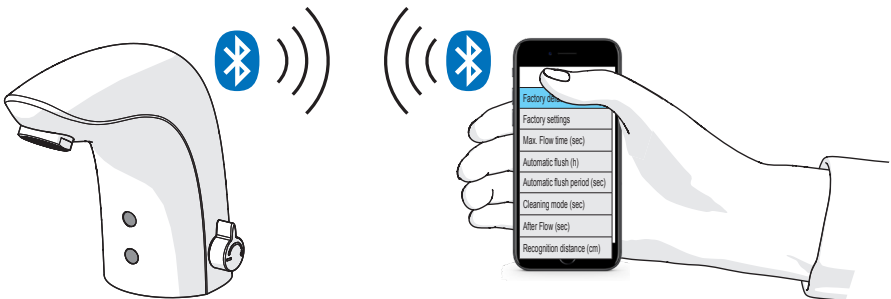
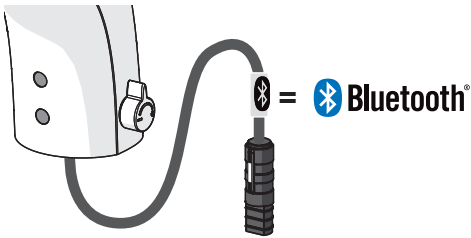

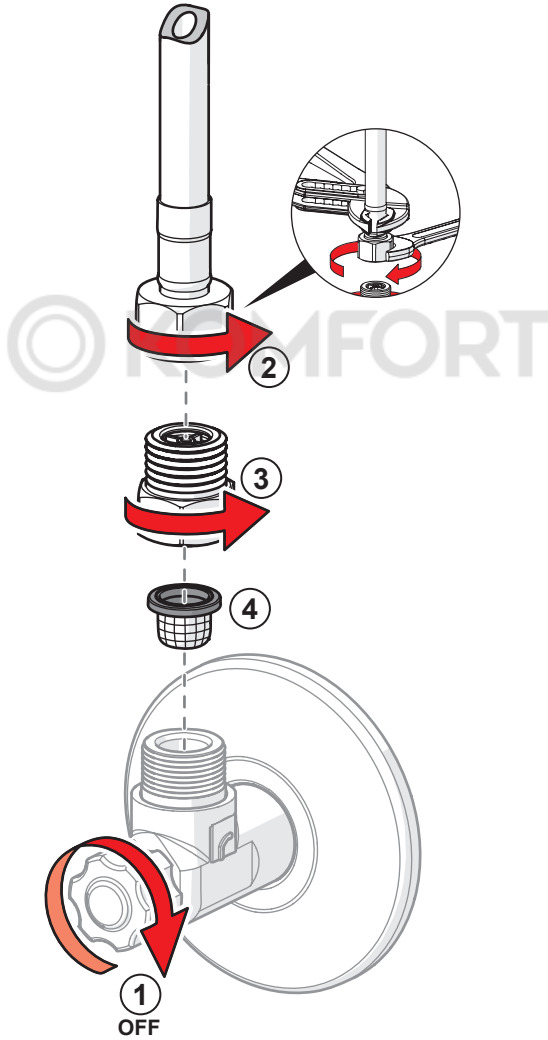
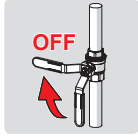

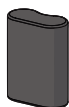
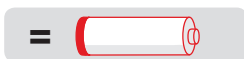

Lithium 2CR5 6V

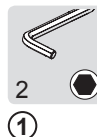
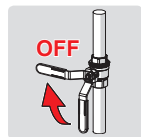

© KOMFORT

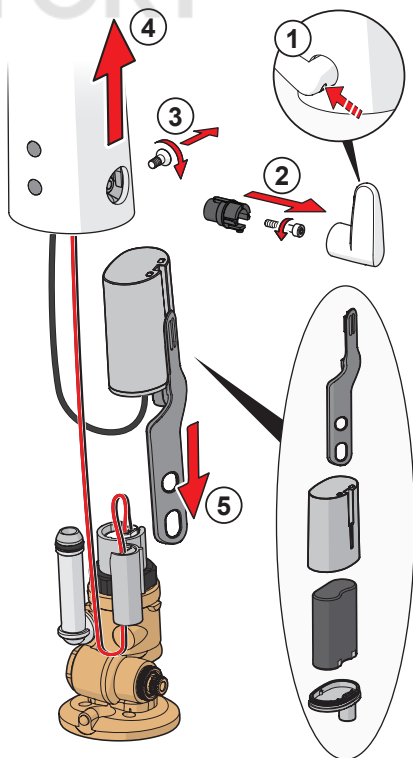
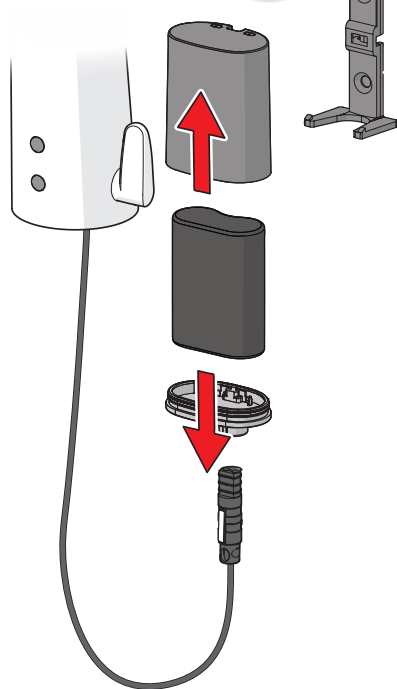

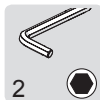

①



②

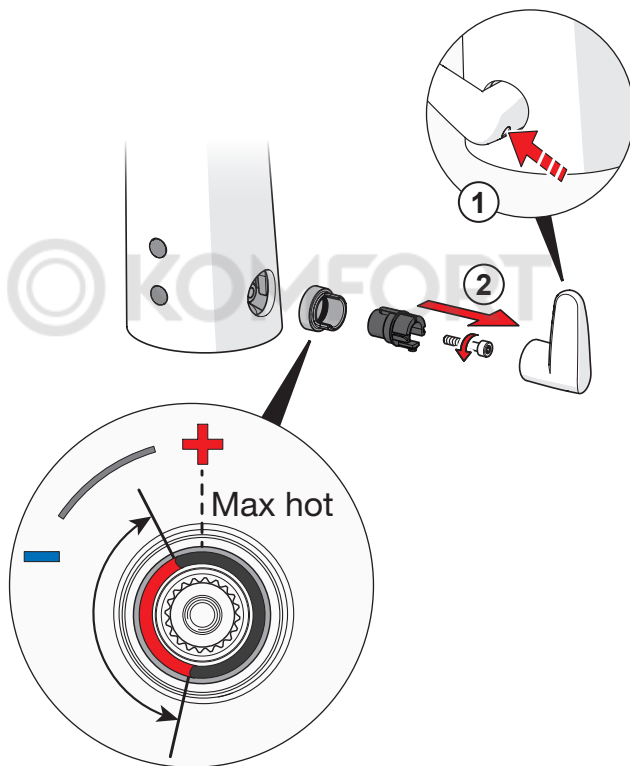

61xx

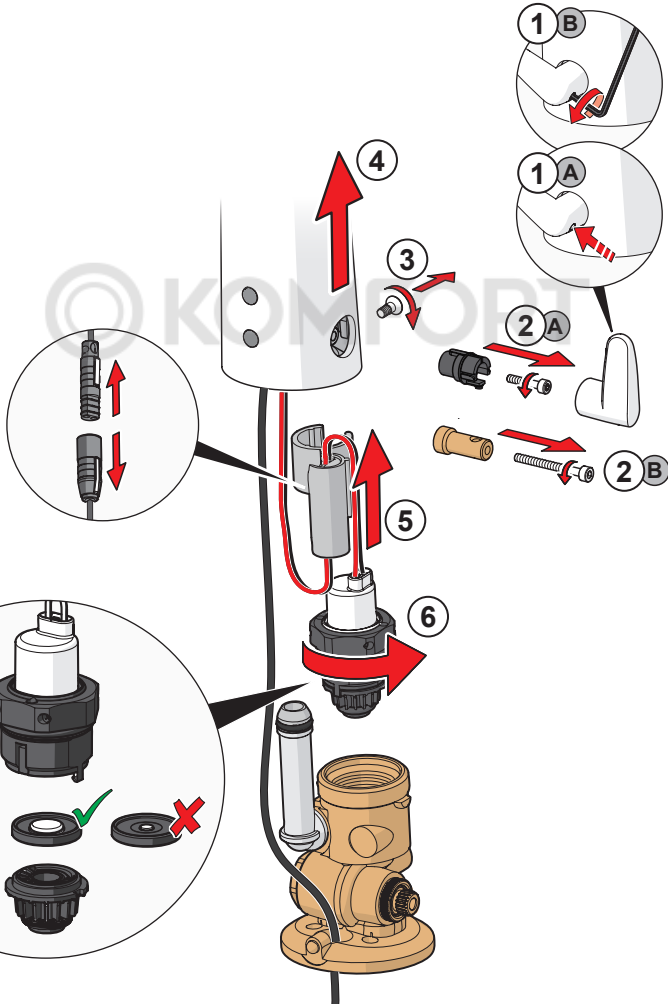
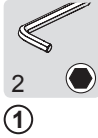
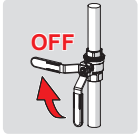

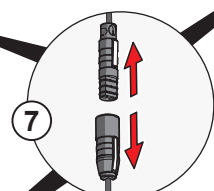
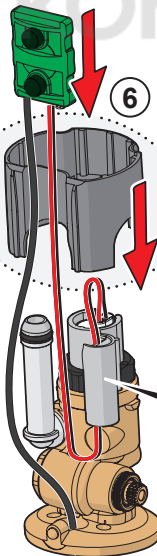
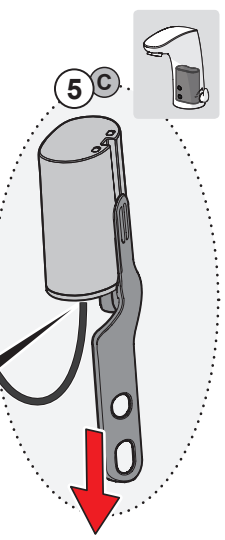
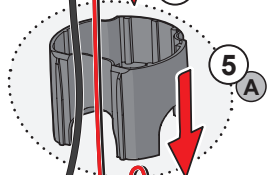
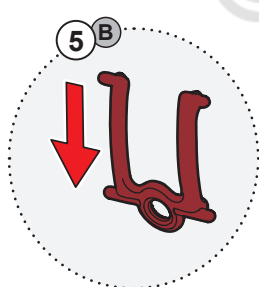
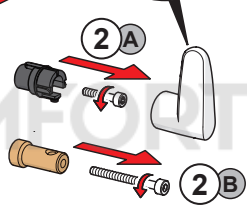
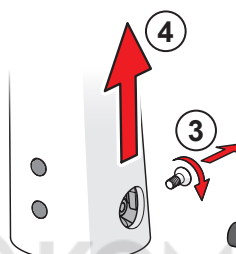
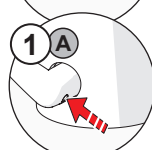
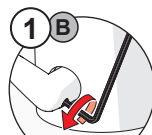
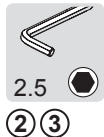
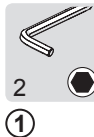
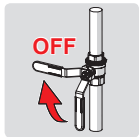

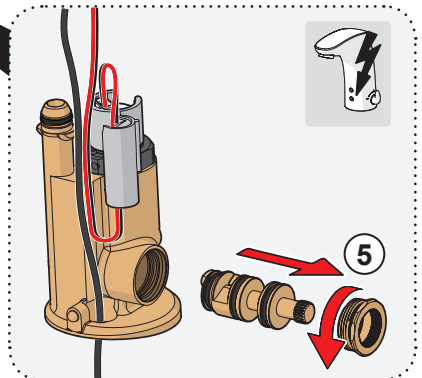
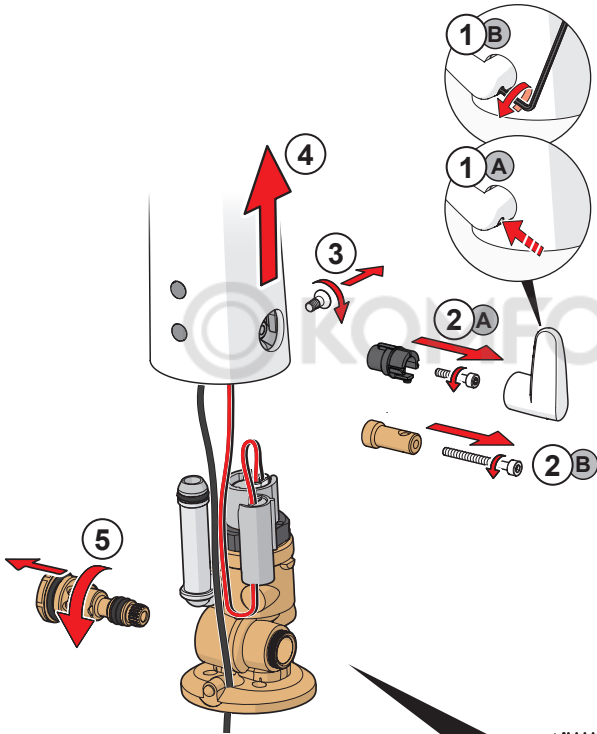
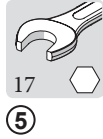
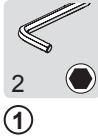
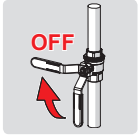

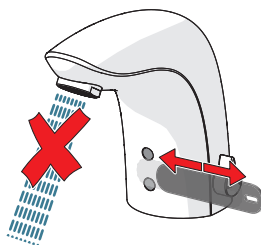
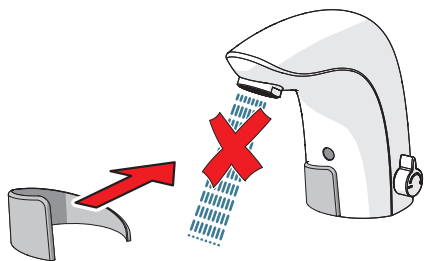

- 1 ON
- 2
- 3
- 4
on 30 s (factory settings)
- 5 automatic off / off

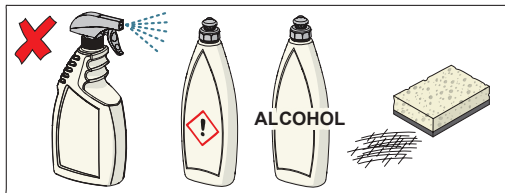
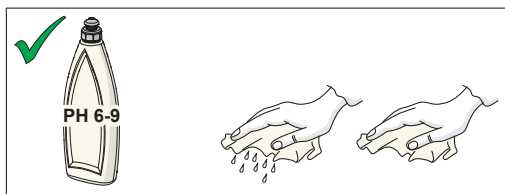
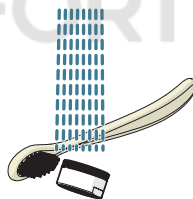
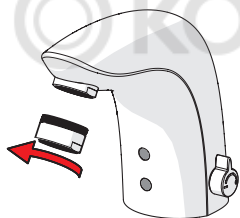

© KOMFORT

© KOMFORT

© KOMFORT

© KOMFORT

Oras Group is a powerful European provider of sanitary fittings: the market leader in the Nordics and a leading company in Continental Europe. The company's mission is to make the use of water easy and sustainable and its vision is to become the European leader of advanced sanitary fittings. Oras Group has two strong brands, Oras and Hansa.

The head office of the Group is located in Rauma, Finland, and the Group has four manufacturing sites: Burglengenfeld (Germany), Kralovice (Czech Republic), Olesno (Poland) and Rauma (Finland). Oras Group employs approximately 1400 people in twenty countries. Oras Group is owned by Oras Invest, a family company and an industrial owner.

ORAS GROUP

Isometsäntie 2, P.O. Box 40

FI-26101 Rauma

Tel. +358 2 83 161

Fax +358 2 831 6300

info.finland@oras.com

www.oras.com

KOMFORT

