



(

)

# PISTOCHE!

3

I.1	.....	3
I.2	PISTOCHE.....	3

4

5

II.1	PISTOCHE.....	5
II.2 PISTOCHE –	.....	6
II.3	.....	8
II.4	.....	9
II.5	, PISTOCHE.....	9

10

III-1	PISTOCHE .....	10
III-2	PISTOCHE .....	17
III-3	.....	19
III-4	– 0,5 .....	21
III-5	.....	22
III-6	.....	24



26

27

V-1	.....	27
VIII.2	.....	27
VIII.3	.....	27
VIII.4	.....	27
VIII.5	.....	28

29

IX.1	.....	29
IX.2	.....	29

30

X.1	0,5 : 2 .....	30
X.2	: 2 .....	30
X.3	: 2 ; 1 .....	30
X.4	: 1 .....	31
XI.5	.....	31

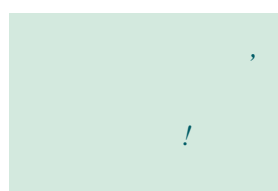

# PISTOCHE!

## I.1

Pistoche

0,5

, 450 / 2,



## I.2

### PISTOCHE

: 2,3 x 2,3

: 0,67

NF P 90-308,

58 : 2320

58 : 2270

230 <sup>2</sup> / 12 <sup>3</sup> / 5 AC

40

58

Pistoche

, 2

PEFC.





!

KOMFORT

Pistoche ( , ),

Pistoche -

3,5

12

3,5

II.1

PISTOCHE

1 ( ):  
 : 0,4 x 0,4 x 0,6  
 : 10  
 :  
 • 0,5  
 •  
 •  
 •  
 •  
 •



2 ( ):  
 : 2,30 x 0,61 x 0,45  
 : 150  
 :  
 •  
 •  
 •  
 •



Pistoche



1/2

II.2 PISTOCHE –

FILTRATION

101	2x35	-
		24

102	5x60	-
		95

103	4x35	-
		8

104	4x20	-
		24

105	4x20	-
		95

106	torx 6x25	-
		16

214	150	-
		6

219		-
		2

220		-
		4

300		-
		1

301		-
		1

302		-
		1

303		-
		1

304		-
		1

305		-
		1

306		-
		1

307		-
		1

308		-
		1

309		-
		2

310		-
		4

400		-
		2

401		-
		2

402		-
		8

403		-
		2

404		-
		6

500		-
		1

501		-
		4



200	2203x68x28	-
		2

201	2203x77x28	-
		2

202	2130x145x28	-
		2

203	2203x145x28	-
		14

204	IV 2204x132x28	-
		4

205	2076x86x28	-
		3

206	2203x127x28	-
		1

207	2187x74x28	-
		1

208	634x86x58	-
		6

209	535x86x58	-
		2

210	584x17x44	-
		6

211	485x17x44	-
		2

212	IV 2099x145x28	-
		4

213	1688 mm	-
		3

215	, 1988	-
		1

216	, 1988	-
		1

217	1980	-
		4

218		-
		1

405		-
		1

II.3

2 : 4



4



T-20 - T-25 - T-30



15 25°C





## II.4

- Pistoche
- Pistoche
- Pistoche
- Pistoche
- Pistoche

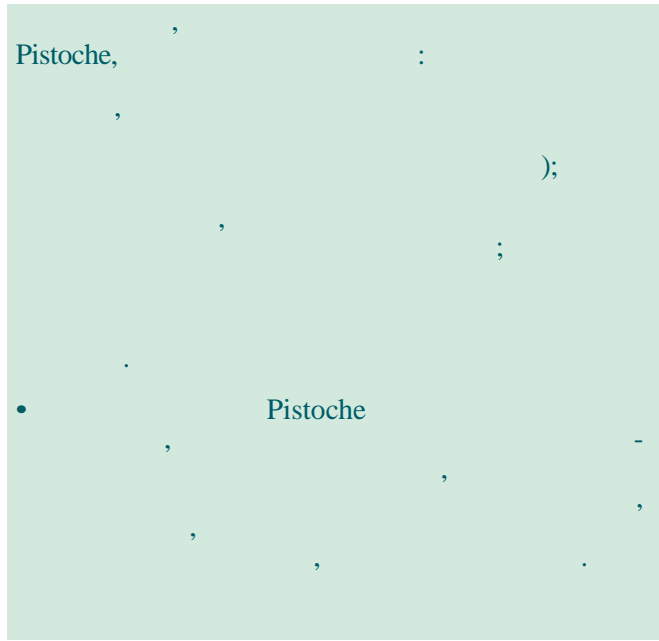

## II.5 PISTOCHE



Pistoche;



III-1

PISTOCHE

201	×2
203	×2
204	×4

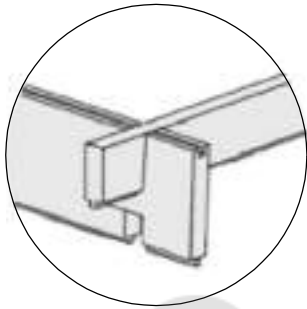

102	×12
-----	-----

5x60.

12

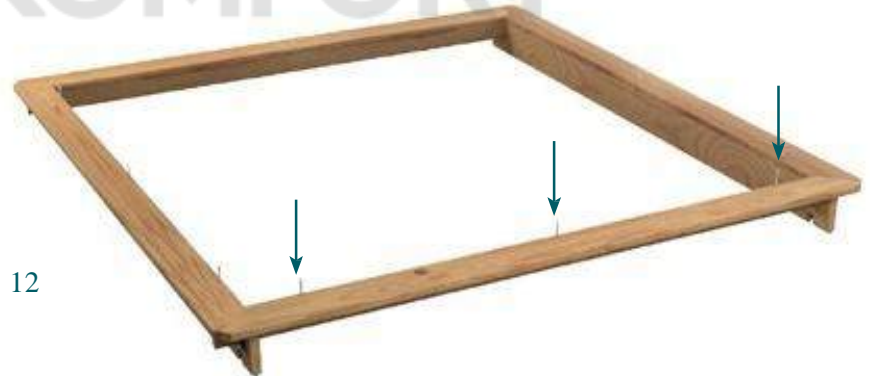

220	×4
106	×16





208	×6
209	×2
102	×16

(204)

(208 209)



(203).



KOMFORT

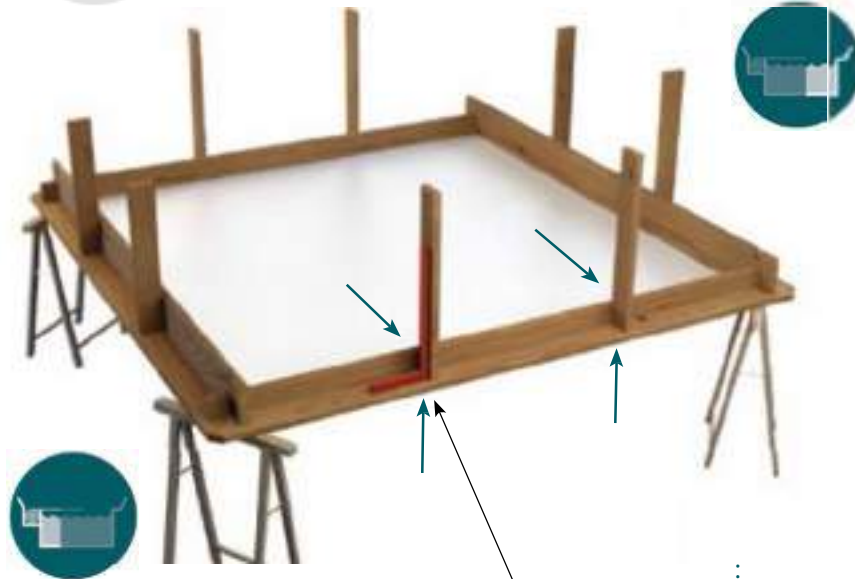

203 ×4



203 ×8  
202 ×2



200 ×2





(208 209) -  
(204).



102 x20



3

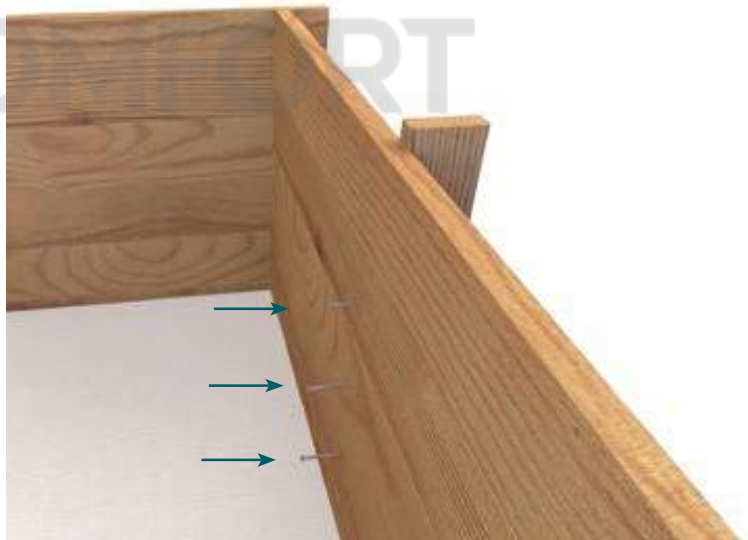





H 4-  
Pistoche.

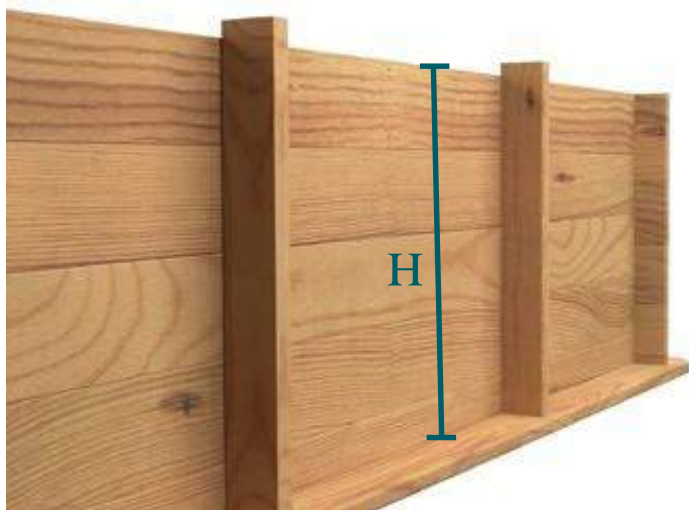

**208** ×6

6 (634x86x58):

(203).



H 2,8  
6

H

6

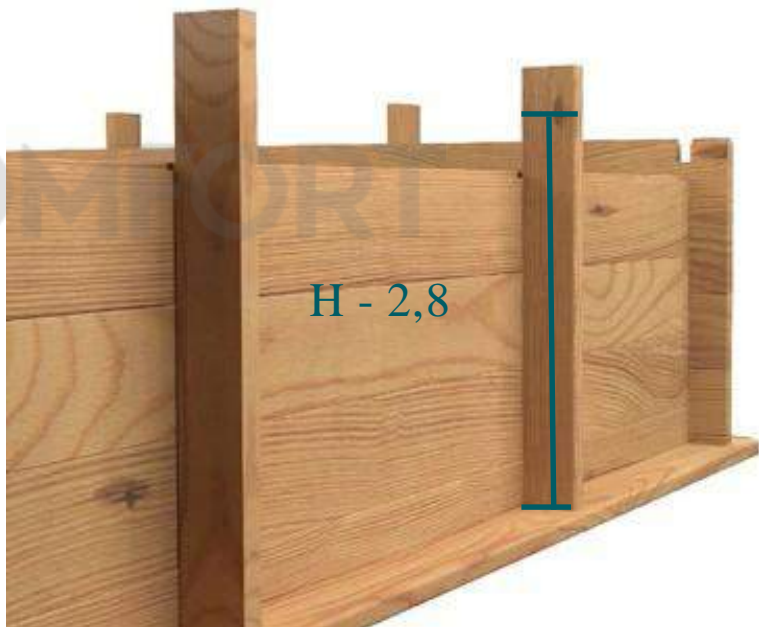

**209** ×2

2 (535x86x58):

(200)  
(203).



H 12,7

2

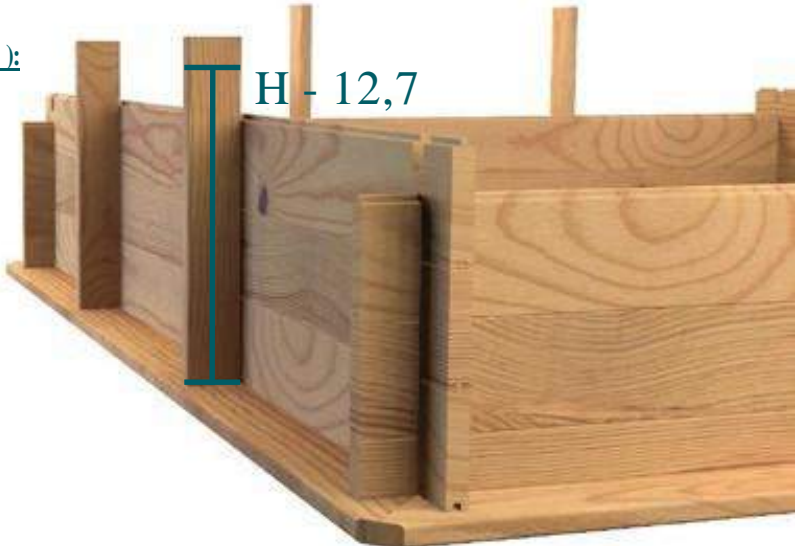



102 x12



205 x3  
102 x15

KOMFORT



(102):

(205)

(203)

(205)

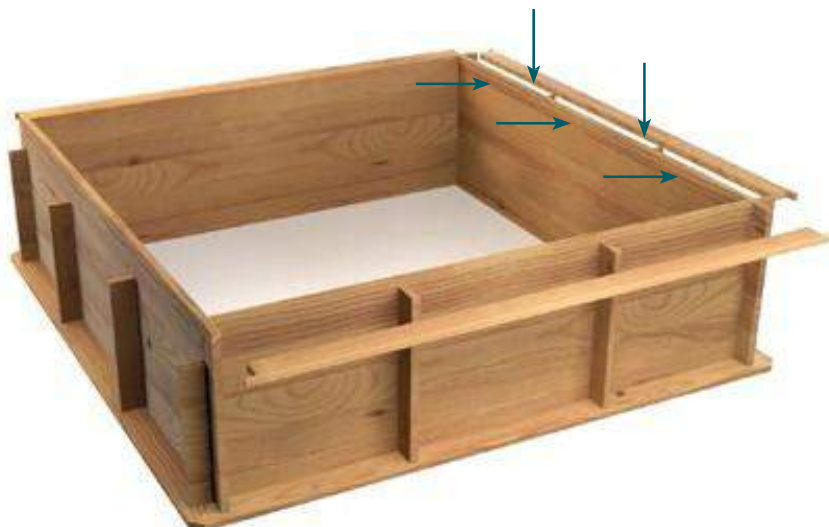



207	×1
102	×7



(203)

(207)

(207),



102	×4
-----	----

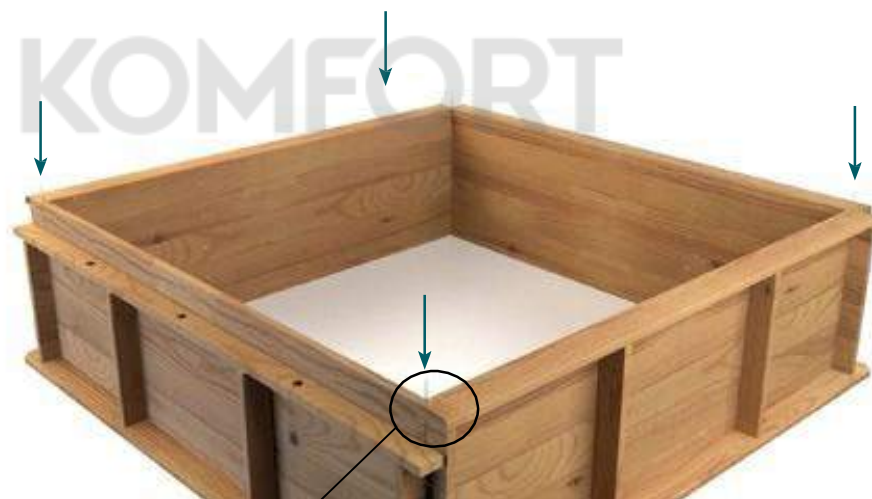

(102).

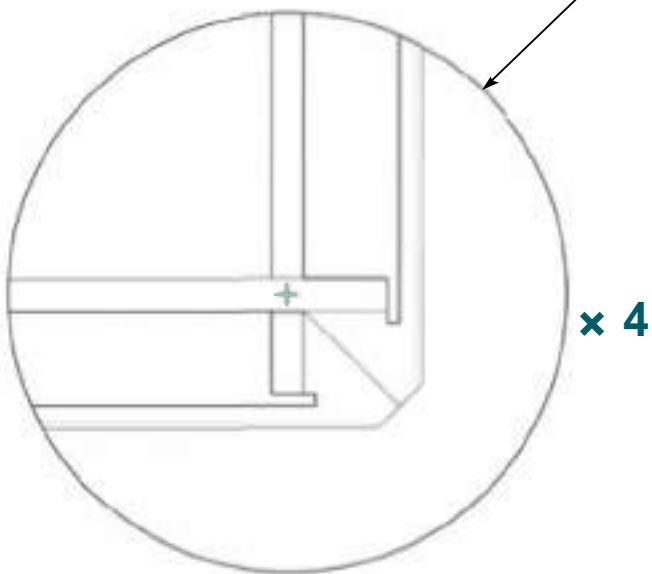



III-2



403	x2
104	x8

400	x1
103	x3

405	x1
-----	----

400	x1
103	x3

PISTOCHE

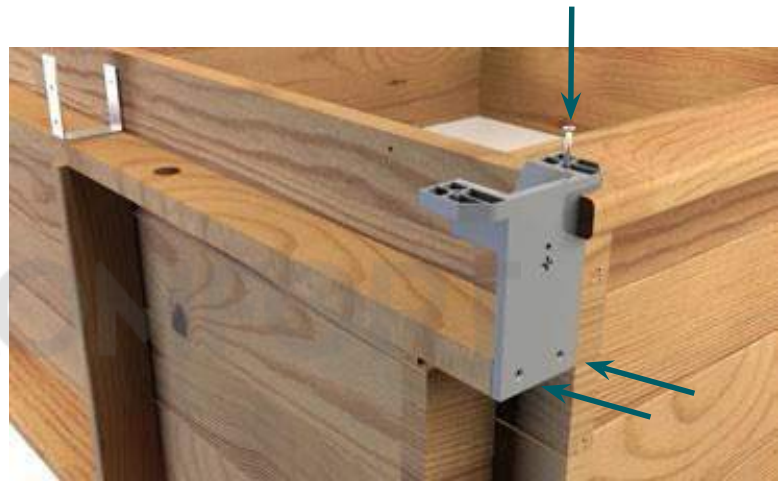



(403)

(104)

206	×1
102	×4
103	×2
104	×2

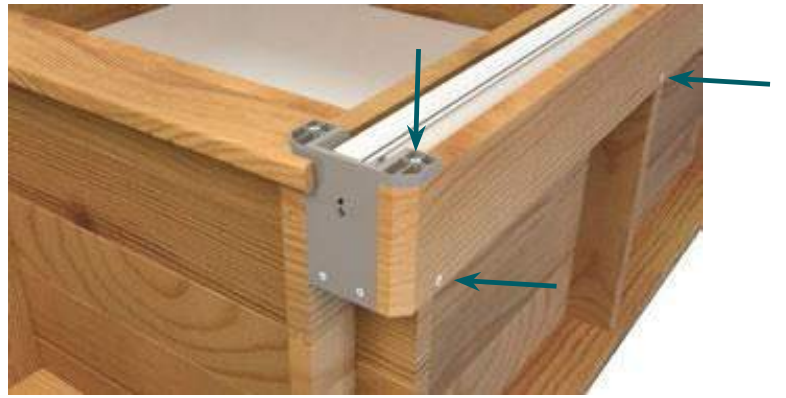

210	×6
211	×2
101	×24



15-

214	×6
105	×18

\_\_\_\_\_ :  
\_\_\_\_\_ :

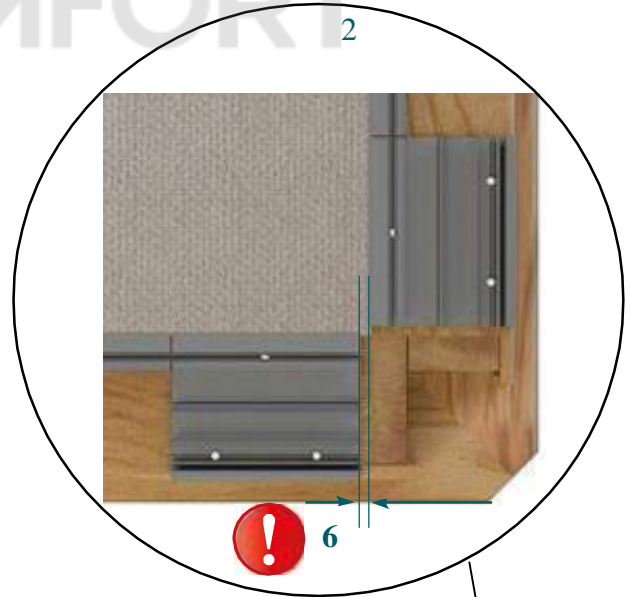
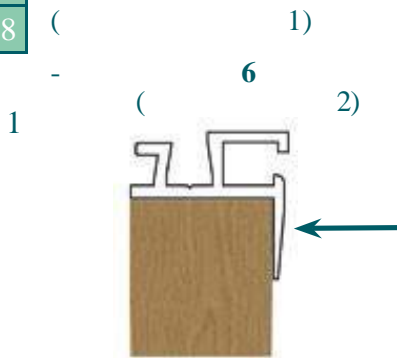

213	×3
105	×12

168,8-

\_\_\_\_\_ :  
\_\_\_\_\_ :

( 1)  
- 15



215	×1
216	×1
105	×8

107

(400).

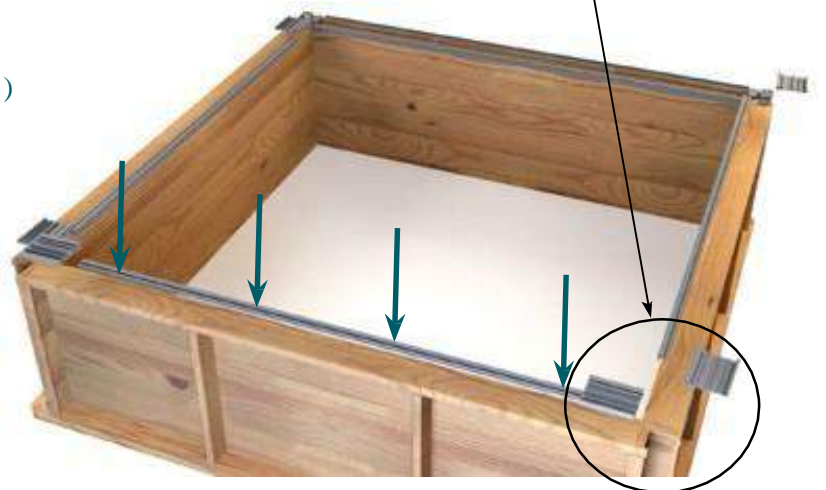

III-3



212	×1
217	×1
219	×2
105	×14

\_\_\_\_\_ :

(217)



(212),

( )



(219).



\_\_\_\_\_ :

KOMFORT



(212), (217),



( )

212	×1
217	×1
105	×8

\_\_\_\_\_ : Просверлите отверстия в алюминиевой полосе (217) согласно схеме ниже.



212	×2
217	×2
105	×16

\_\_\_\_\_ : Просверлите отверстия в алюминиевой полосе (217) согласно схеме ниже.

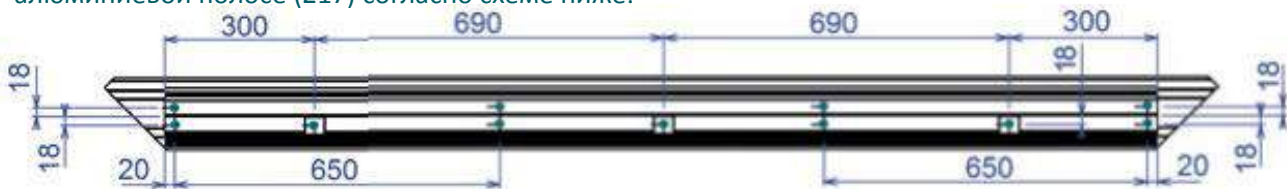

404	×6
104	×6





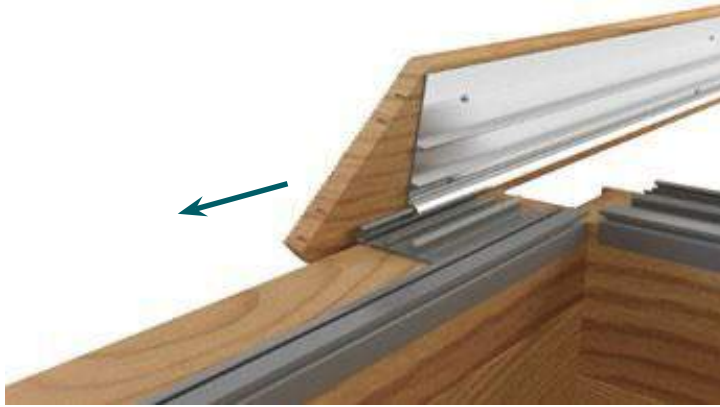

402	×8
105	×8

© KOMFORT

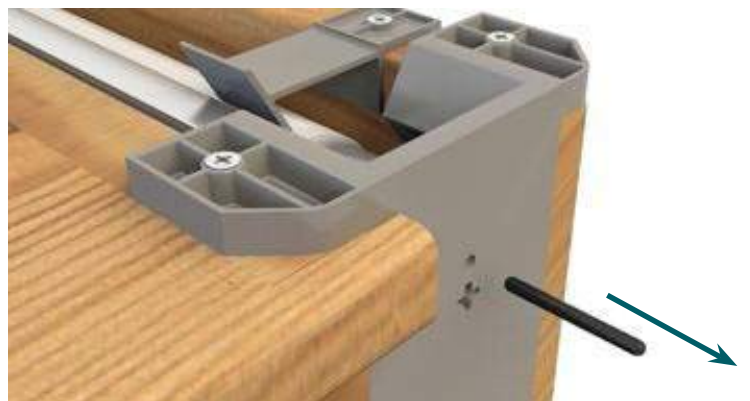
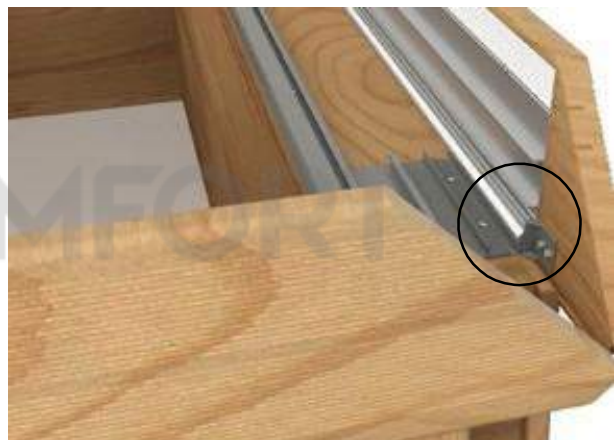

III-4

0,5



218	×1
500	×1



© KOMFORT (213 216)



500	×1
-----	----

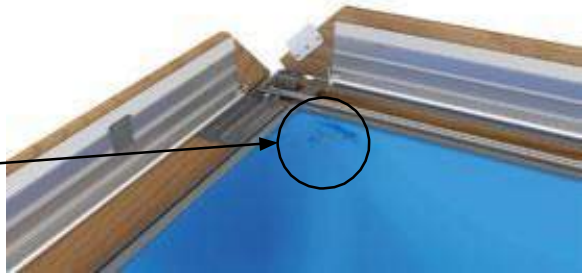

40 58



( 24).

III-5

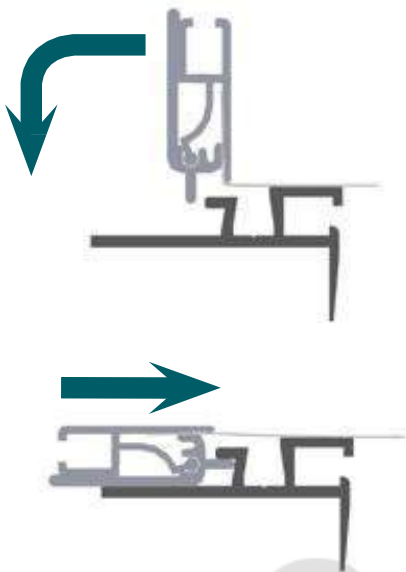

- 401 x2
- 104 x2



KOMFORT



3





© KOMFORT



(213),

Pistoche.



III-6

- 301 ×1
- 302 ×1

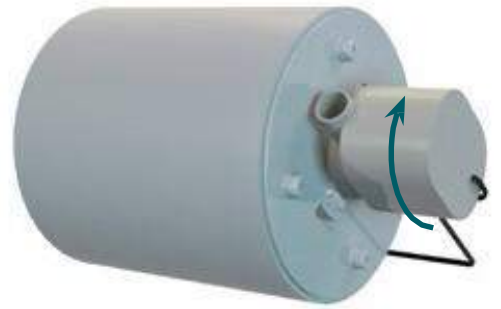
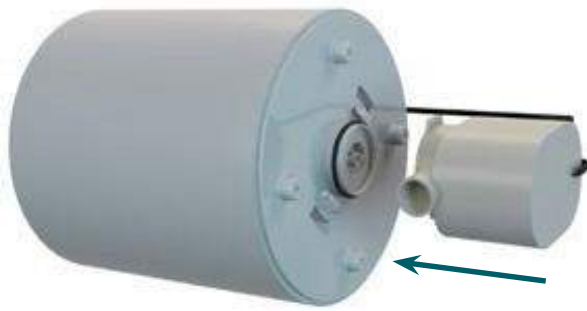

- 300 ×1
- 105 ×4



- 303 ×1

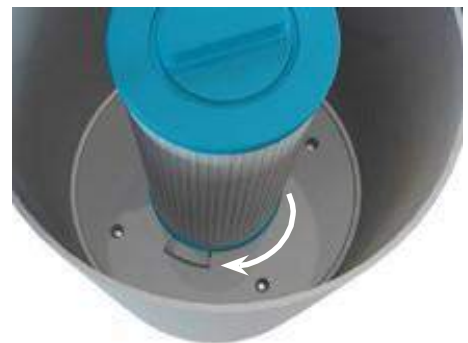
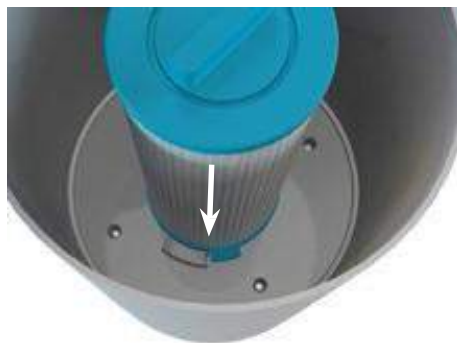



304 ×1  
105 ×2

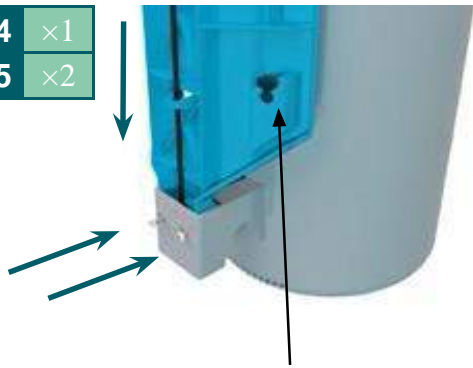

2

305 ×1  
307 ×1



306 ×1  
308 ×1  
309 ×4



(308)  
(306).

(309)

4

(306)



40



50



58



V-1

( Pistoche) ;  
4)  
5)  
1) ;  
2) ;  
3) ;

VIII.2



VIII.3

;

VIII.4

(pH > 7,8 pH),  
pH ( 6,8  
7-7,5; pH  
- •

### VIII.5



5  
1,5

58

90

IX.1

- 1) ( ; 3) ; 4) 20 ; 5)
- 2) ;

IX.2



**X.1**

**: 2**

( . IX, XII XIII.4) •  
 ( . XIII.4)  
 : •  
 •  
 •  
 •  
 pH - 28°C,  
 7,2 - 7,6,



**X.2**

**: 2**

III, VI, VII VIII. ( )  
 ( )

**X.3**

**: 2**

**; 1**

VIII, IX.5. •  
 :

**X.4**

**: 1**

IX.1.

**XI.5**



© KOMFORT

*Pistoche*.fr by PROCOPI